

(202012)

2020 12 04

1

C3360

300d

3 1

15015001113

80000

800

30000

7000

40

400

(1) 项目 A 栋一楼 1 车间生产工艺流程

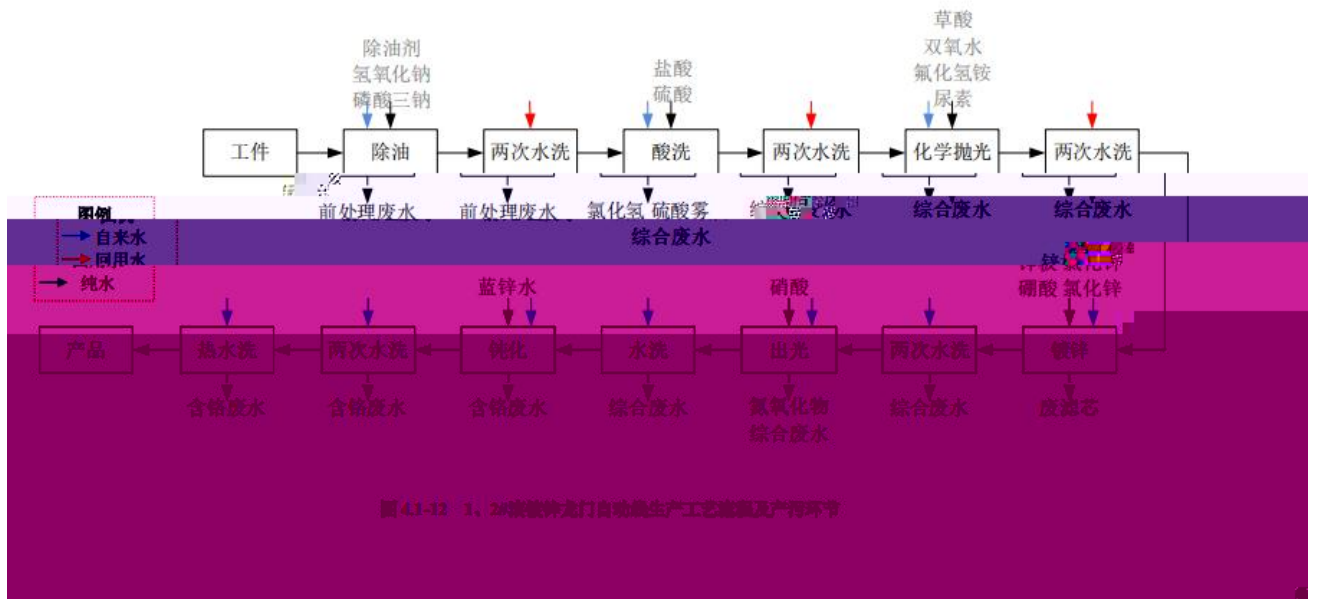

(2) 项目 A 栋一楼 2 车间生产工艺流程

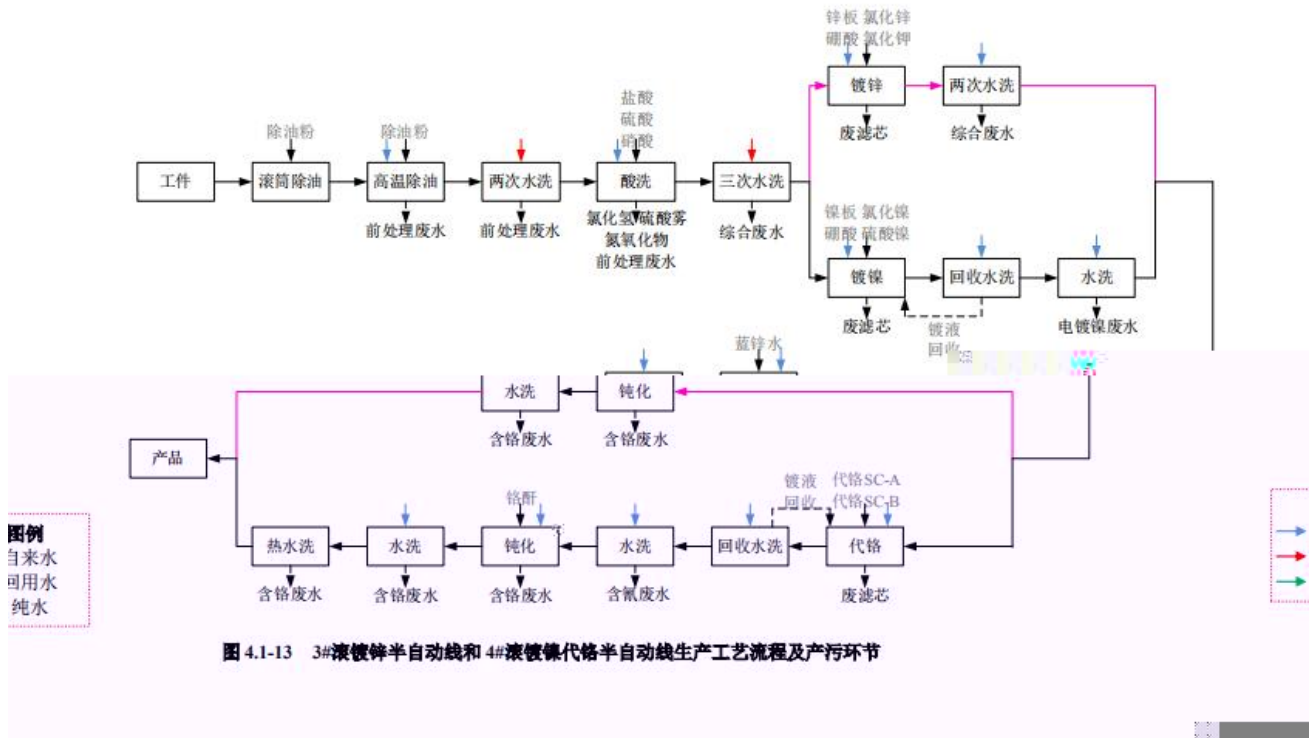

(3) 项目 A 栋一楼 3 车间生产工艺流程



图 4.1-14 5#挂镀首饰手动线生产工艺流程及产污环节

(4) 项目 A 栋一楼 4 车间生产工艺流程



(5) 项目 A 栋二楼 1 车间生产工艺流程

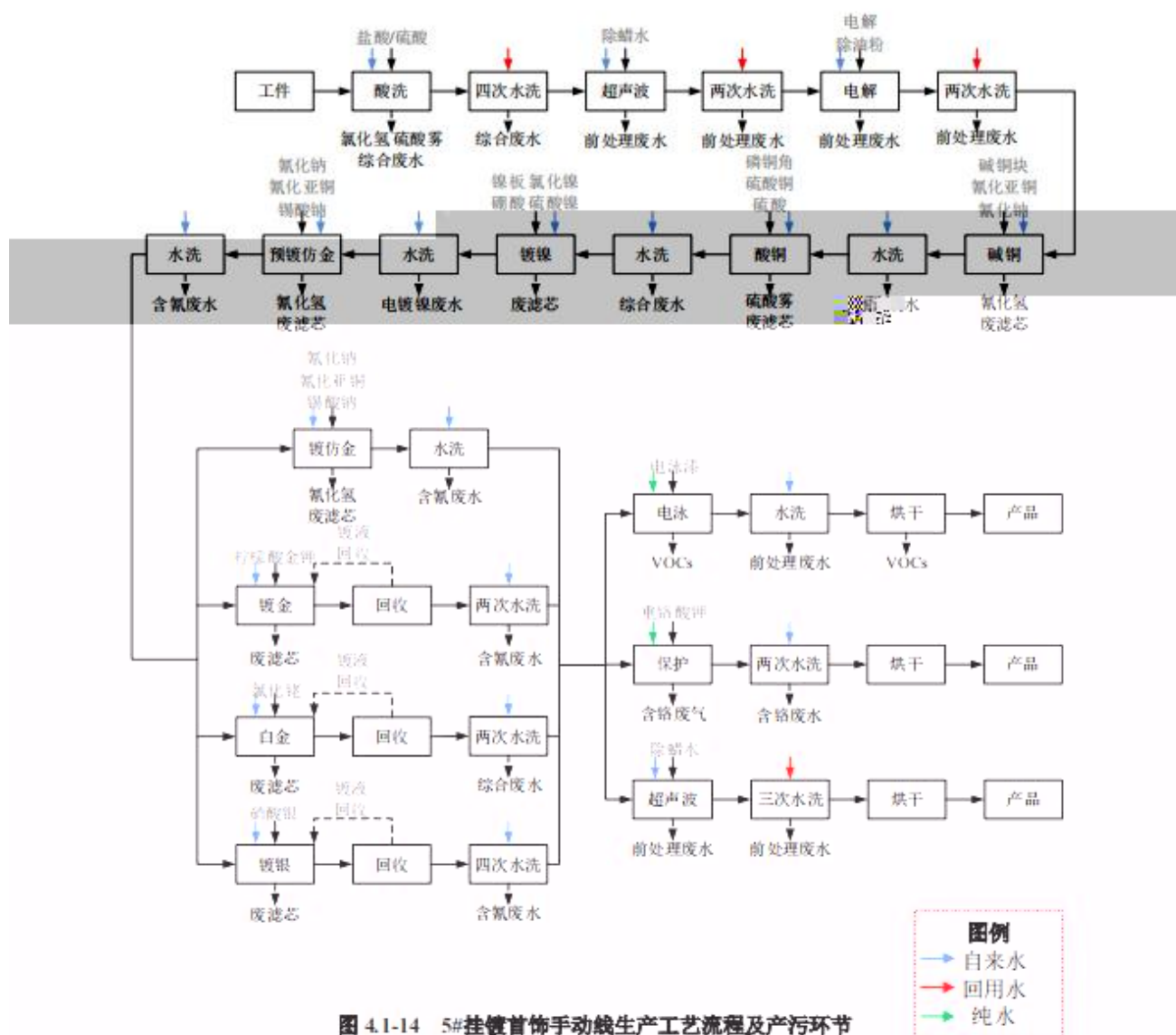
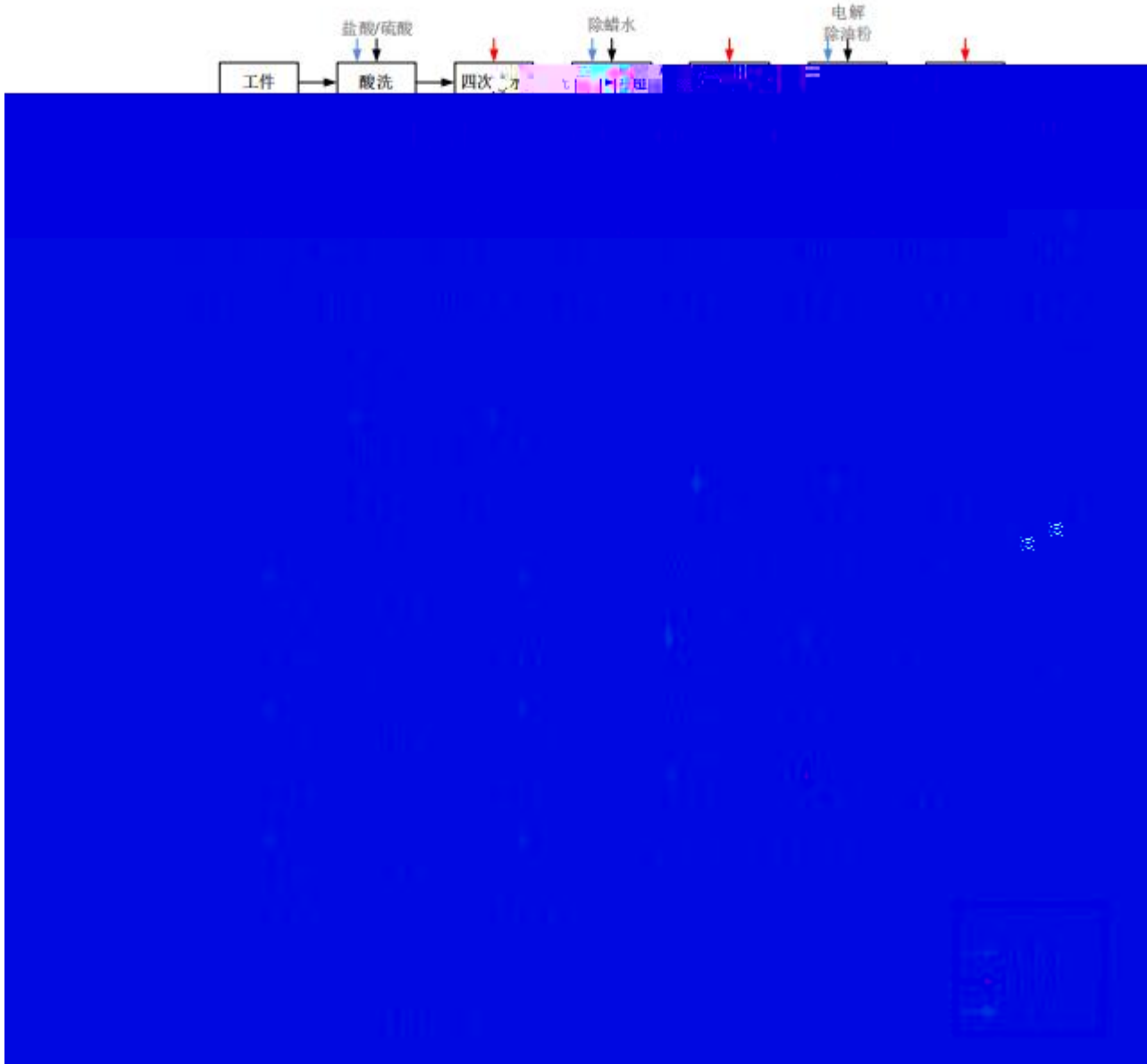
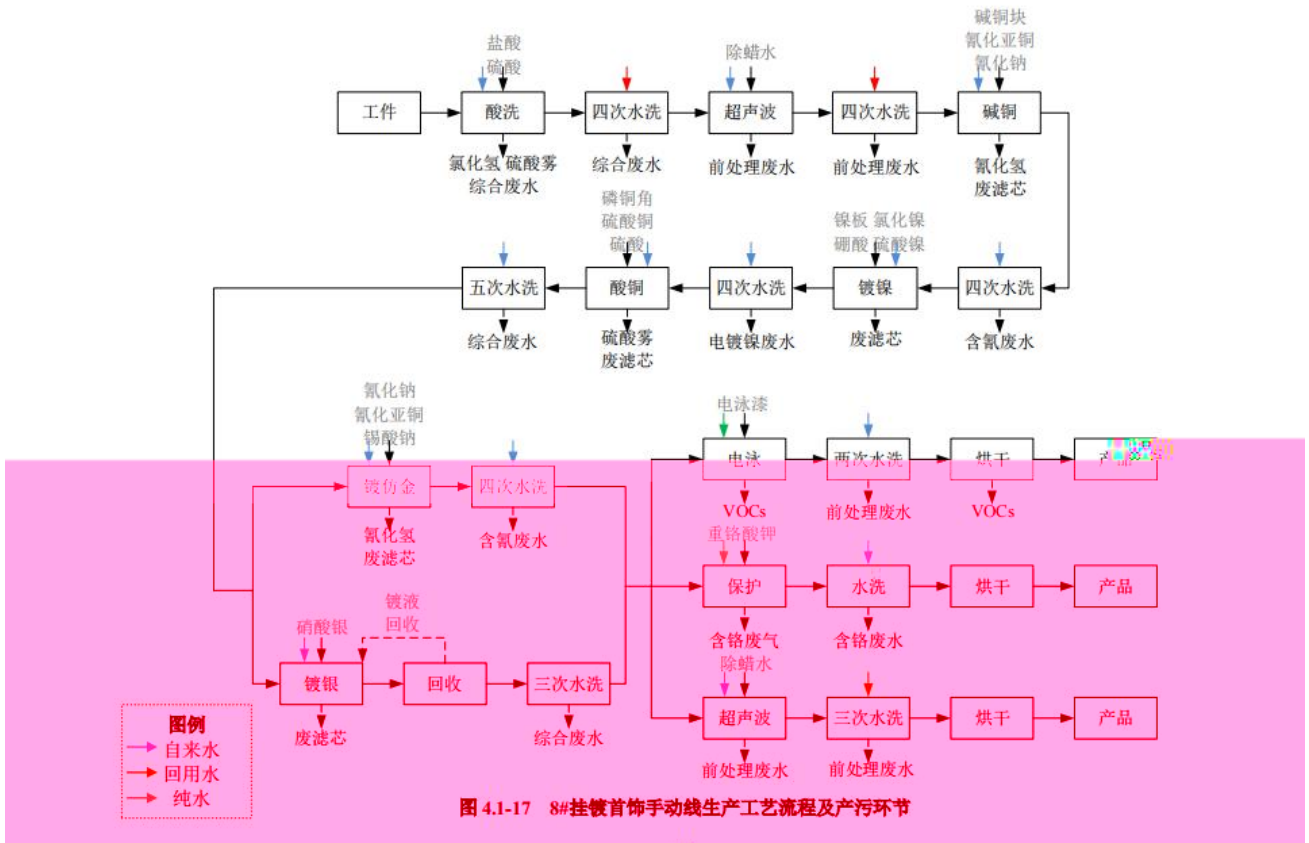
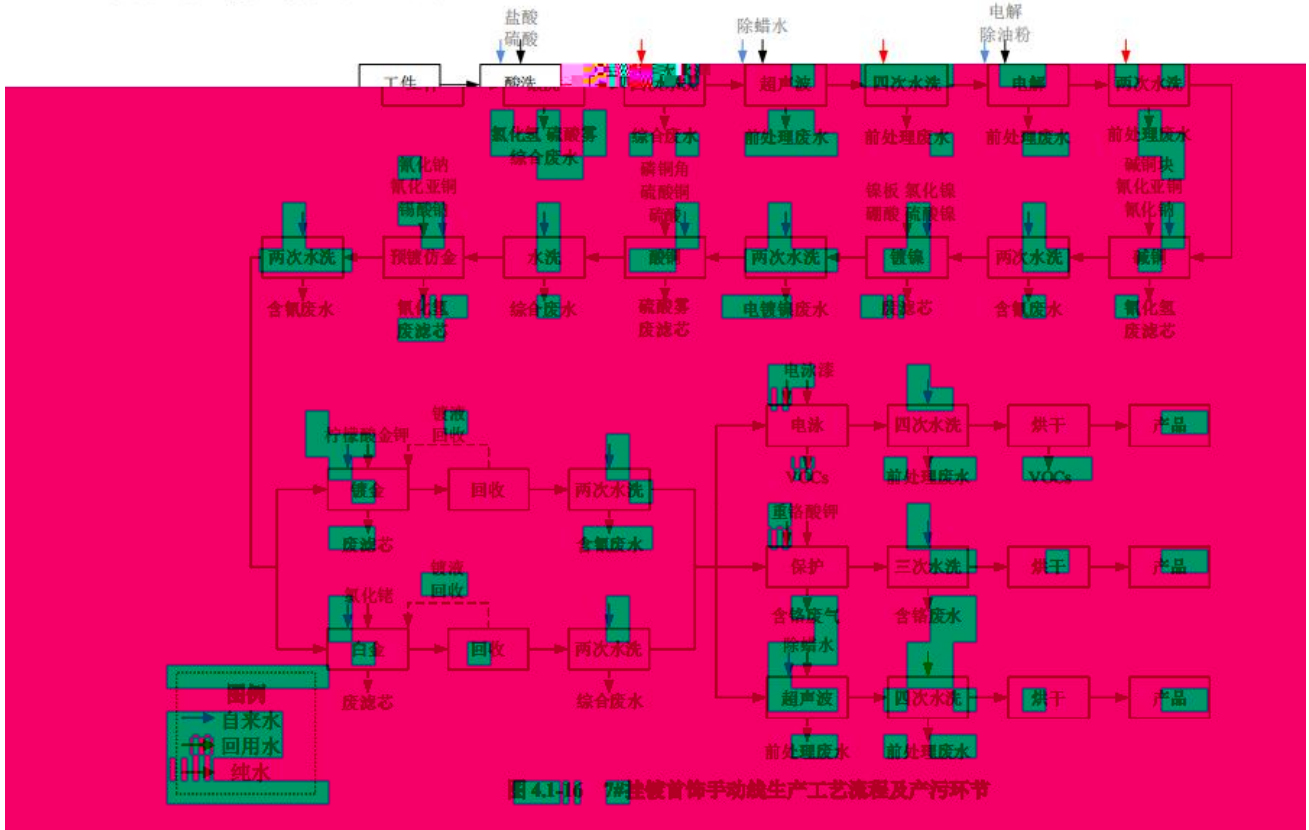

(6) 项目 A 栋二楼 2 车间生产工艺流程

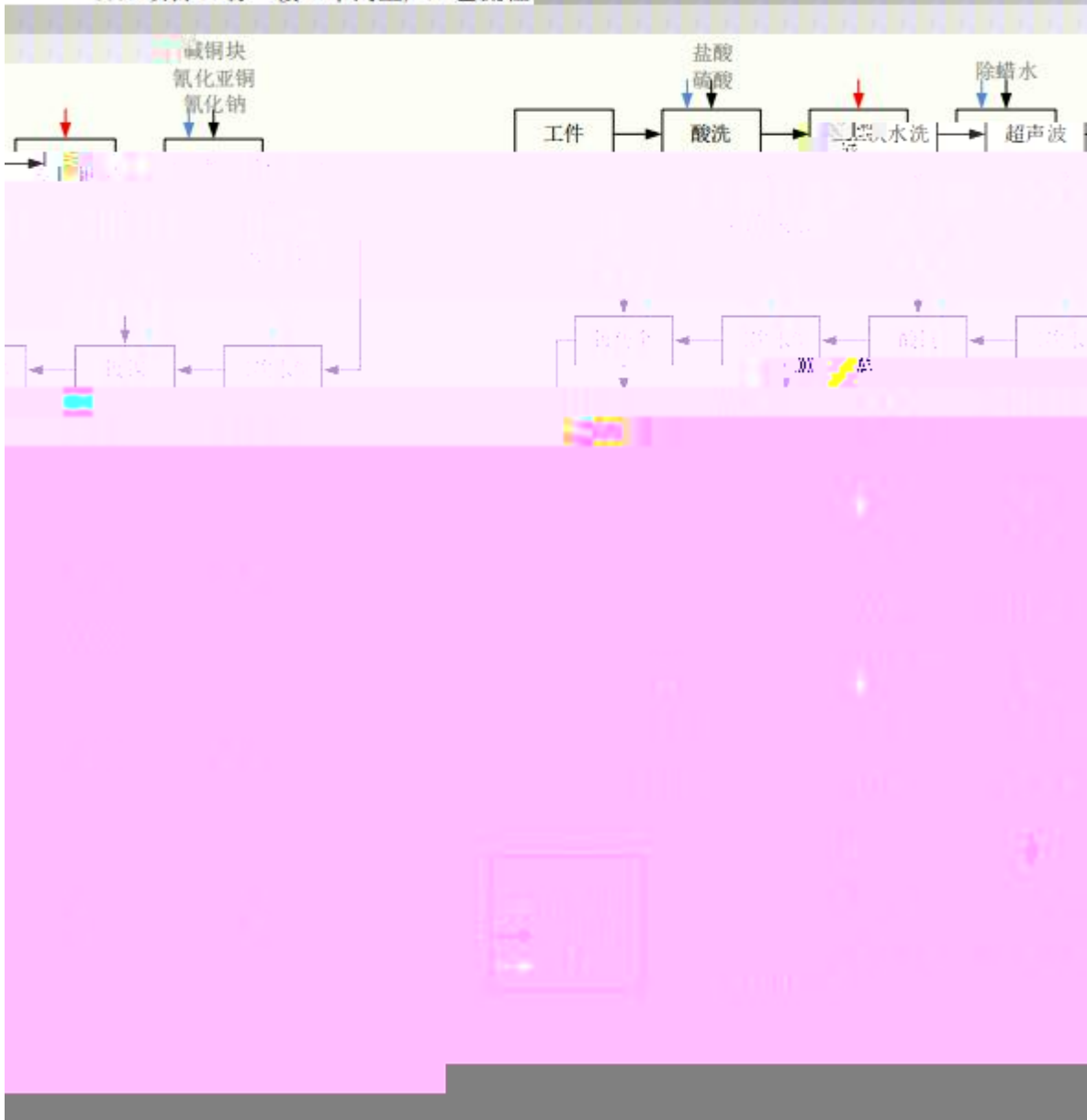

(7) 项目 B 栋一楼生产工艺流程



图 4.1-19 (10) 滚镀锌半自动线生产工艺流程及产污环节



图 4.1-20 (11) 滚镀锌半自动线生产工艺流程及产污环节

(8) 项目 B 栋二楼生产工艺流程

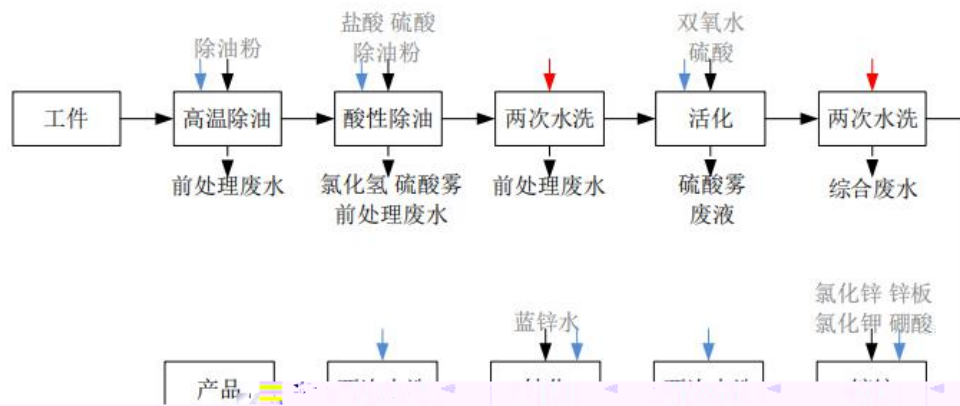

图 4.1-21 12#不锈钢电解线生产工艺流程及产污环节

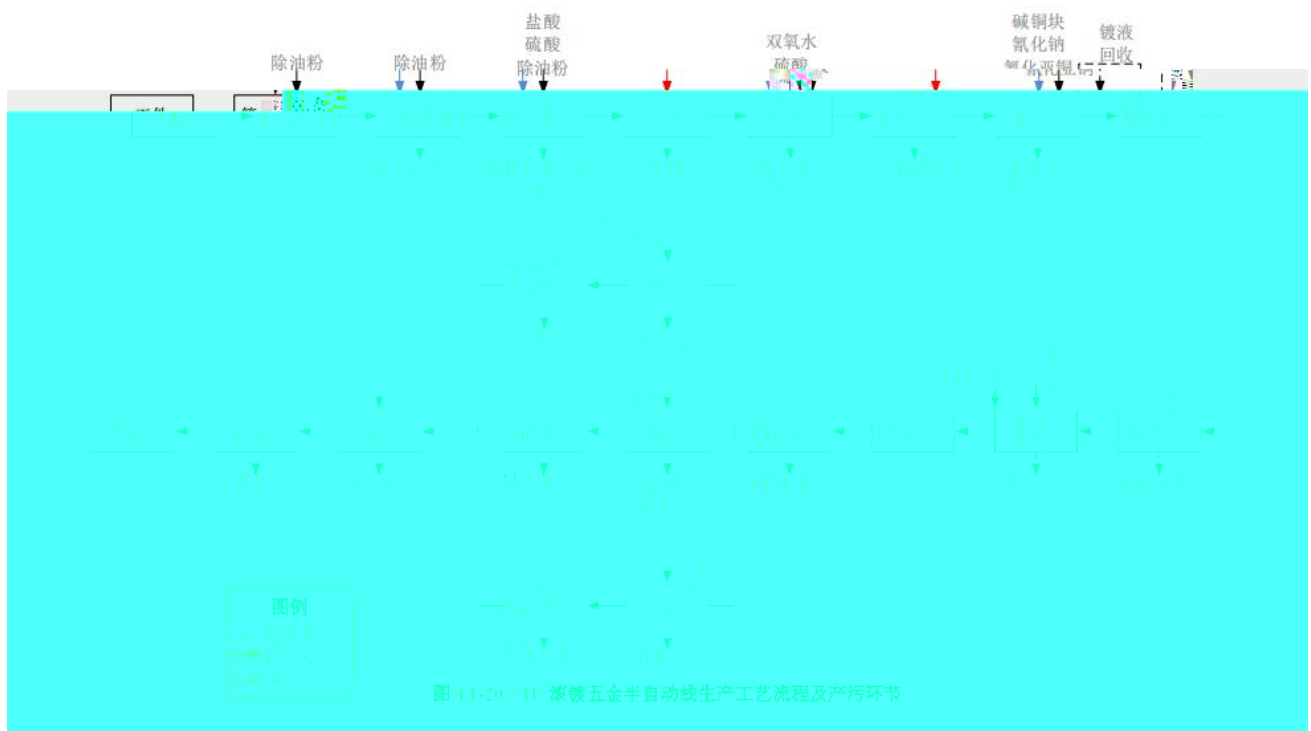
(9) 项目 B 栋三楼生产工艺流程



图 4.1-22 13#挂镀五金半自动线生产工艺流程及产污环节

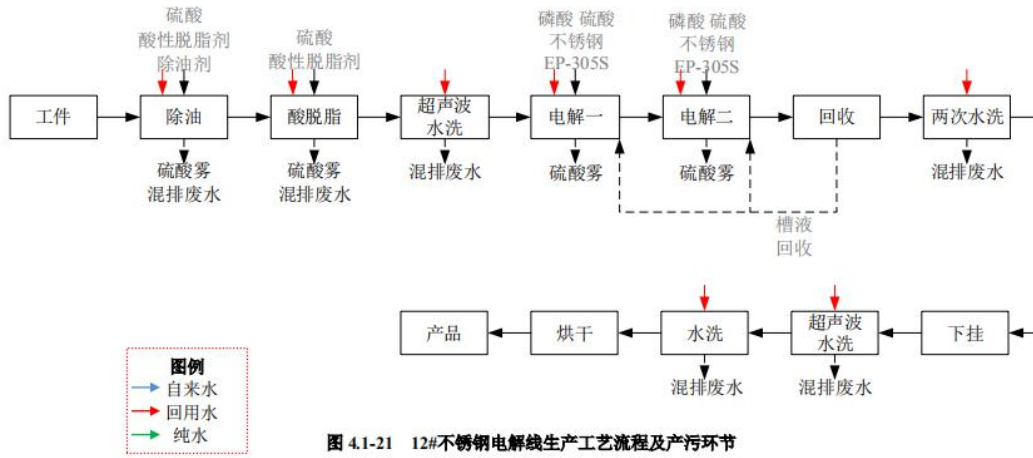

图 4.1-23 13#挂镀五金半自动线配套退镀工艺流程及产污环节

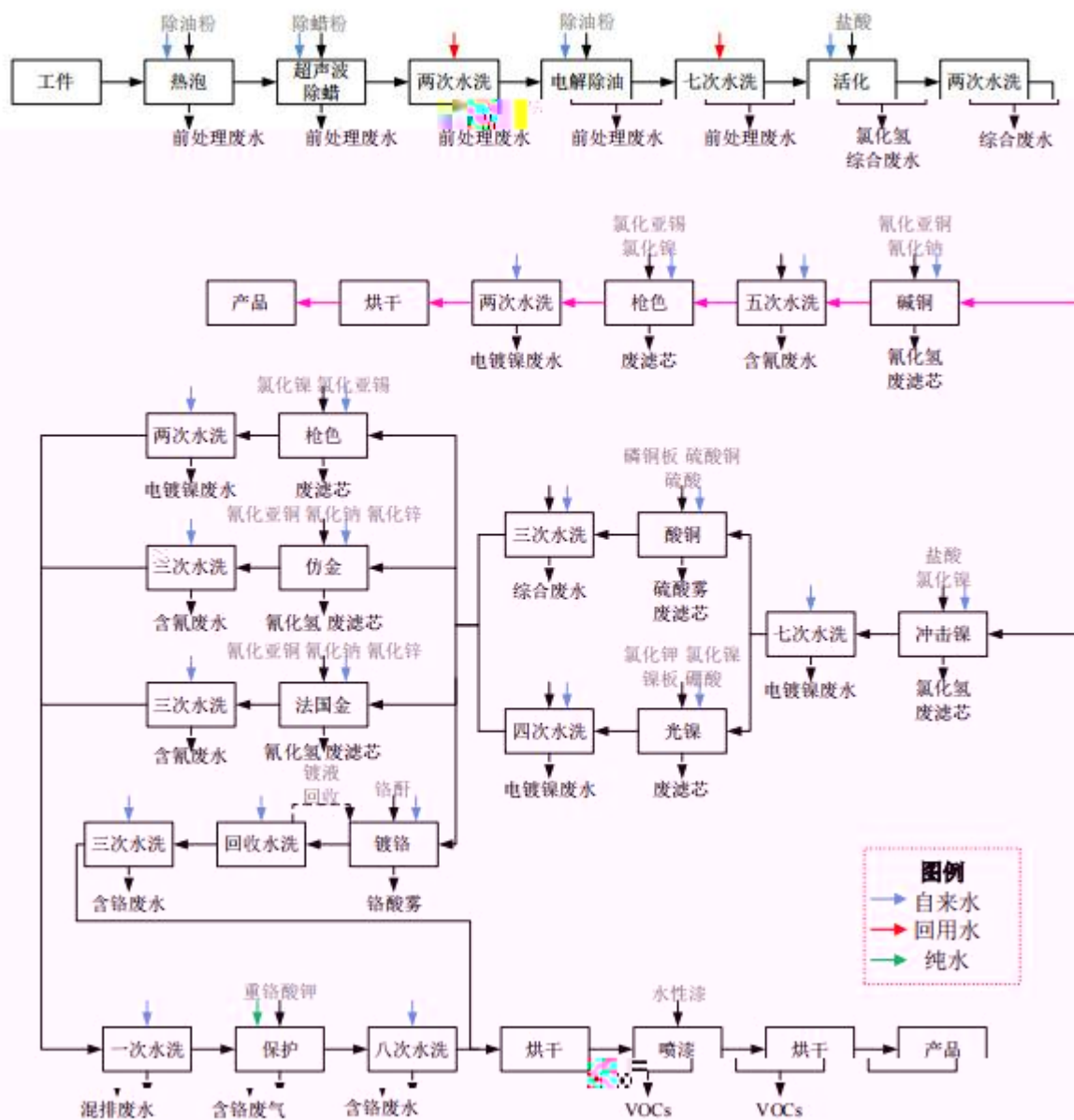

图 4.1-24 贵金属回收工艺装置示意图

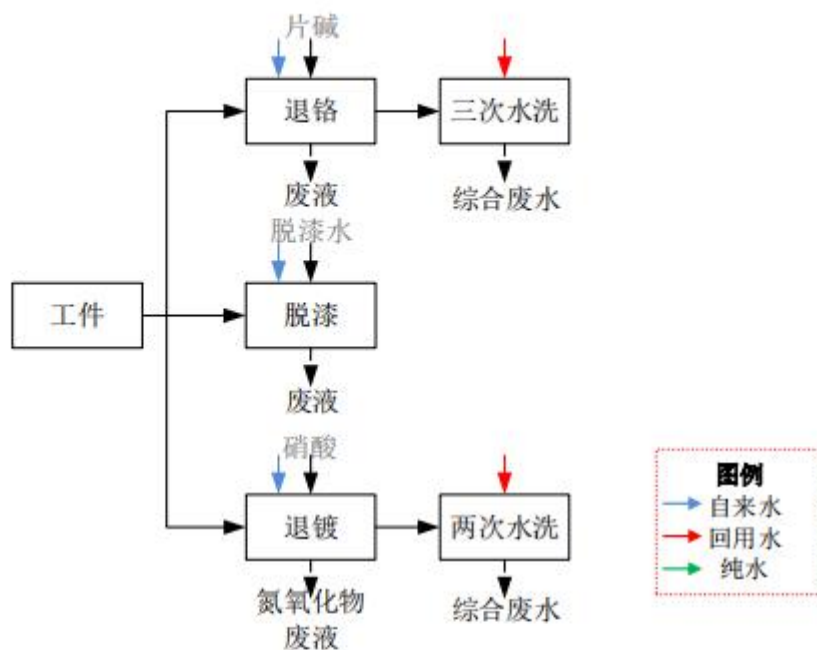

2

3

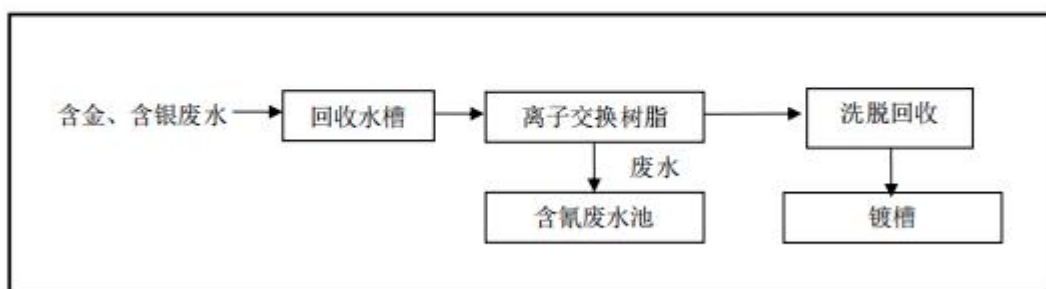
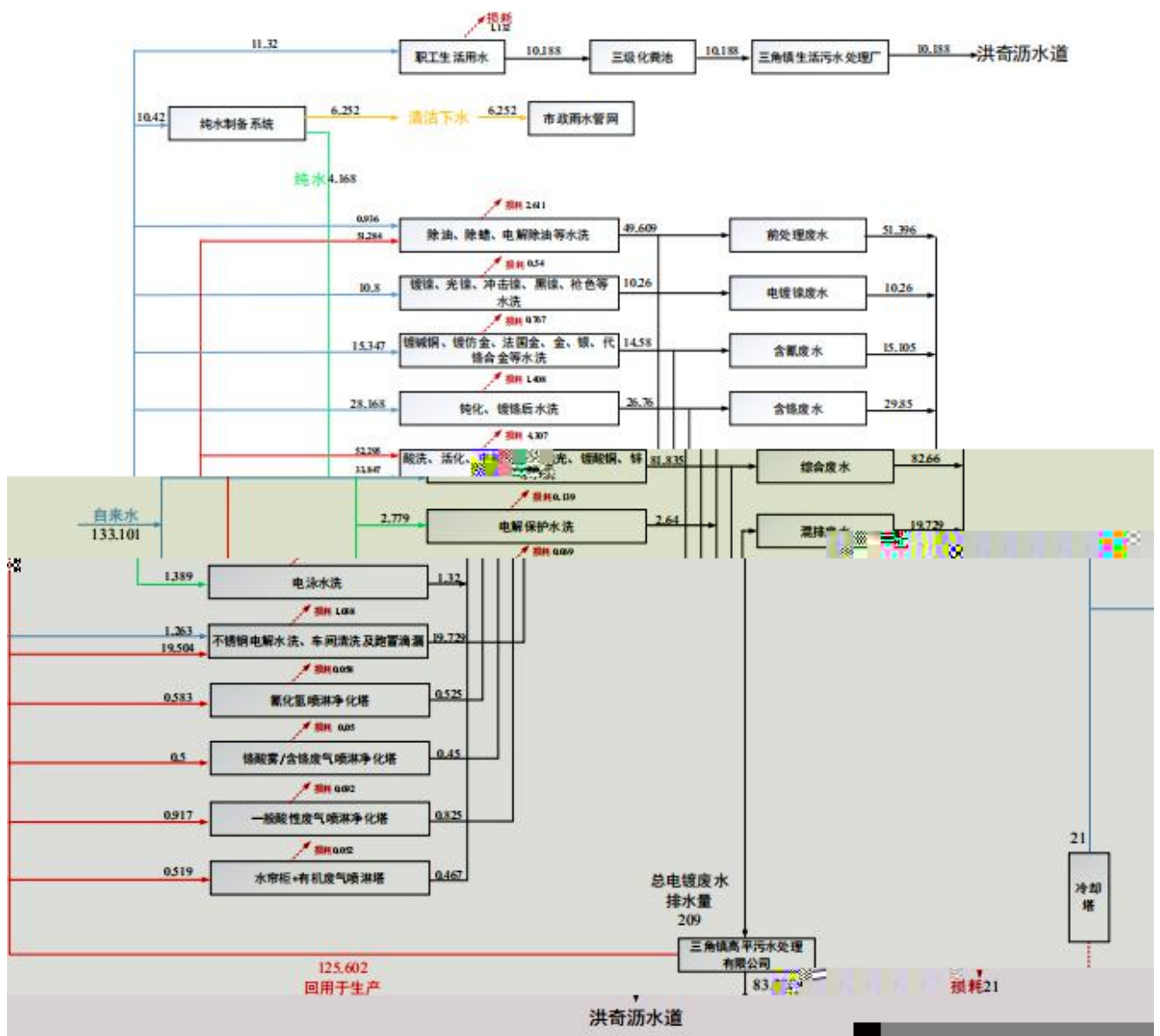
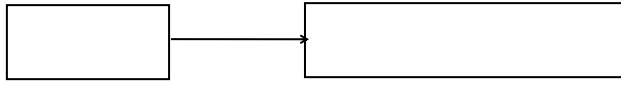

1

1

A

15m B

20m



图4.1-1 酸性废气处理工艺流程

2

" + + "

A 15m B

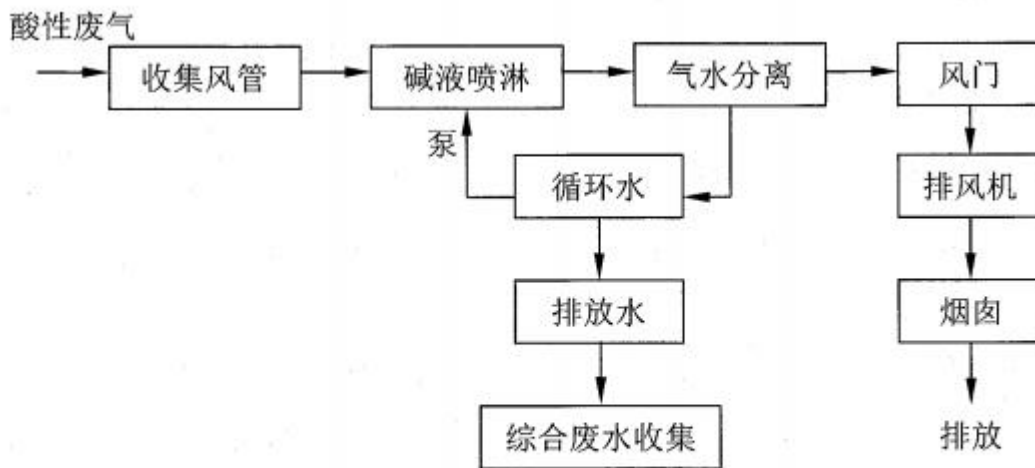
20m

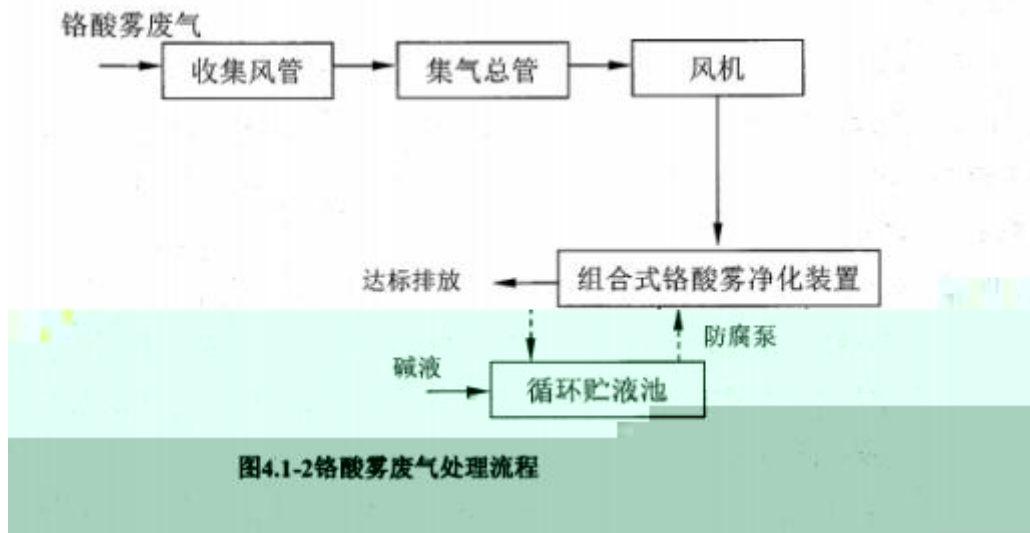

3

1.5%

25m

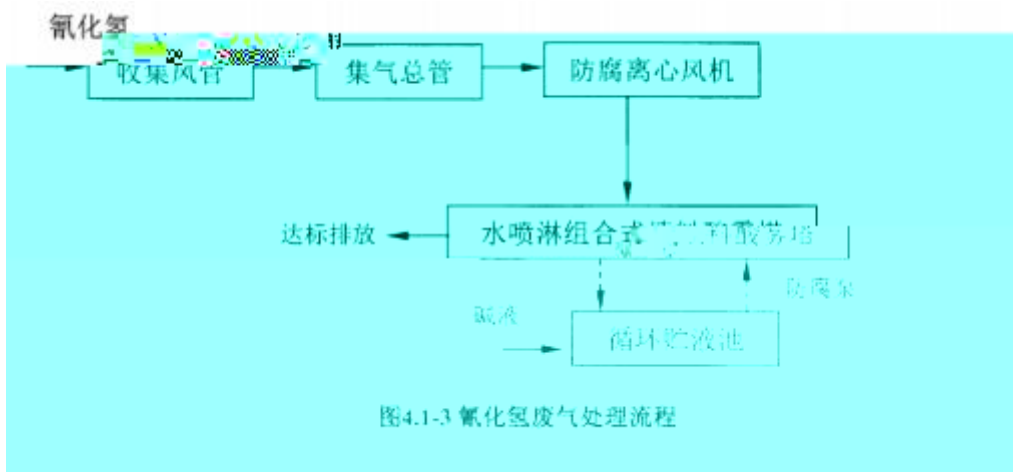

2



图4.1-4 A栋有机废气处理流程



图4.1-5 B栋有机废气处理流程

3

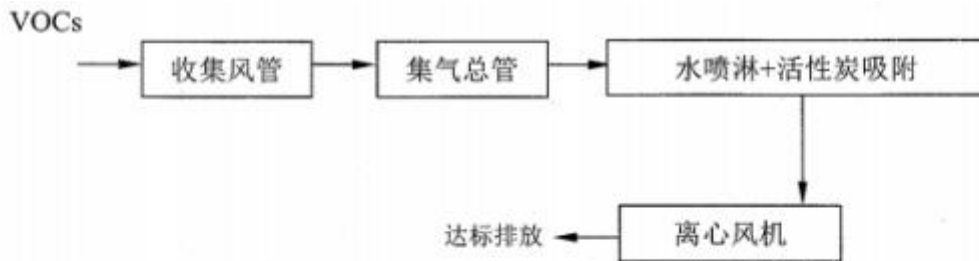
4

2

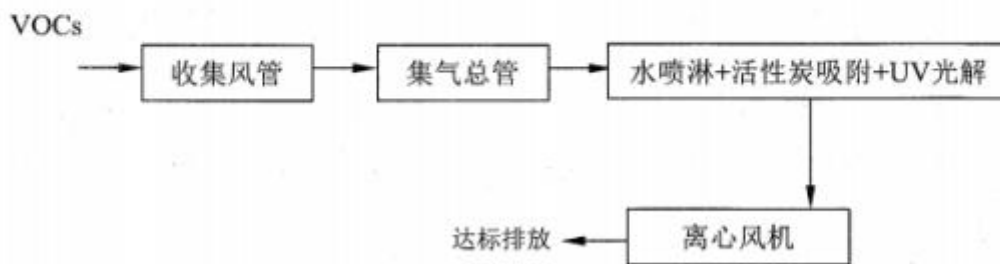
2.1

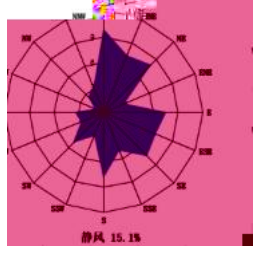
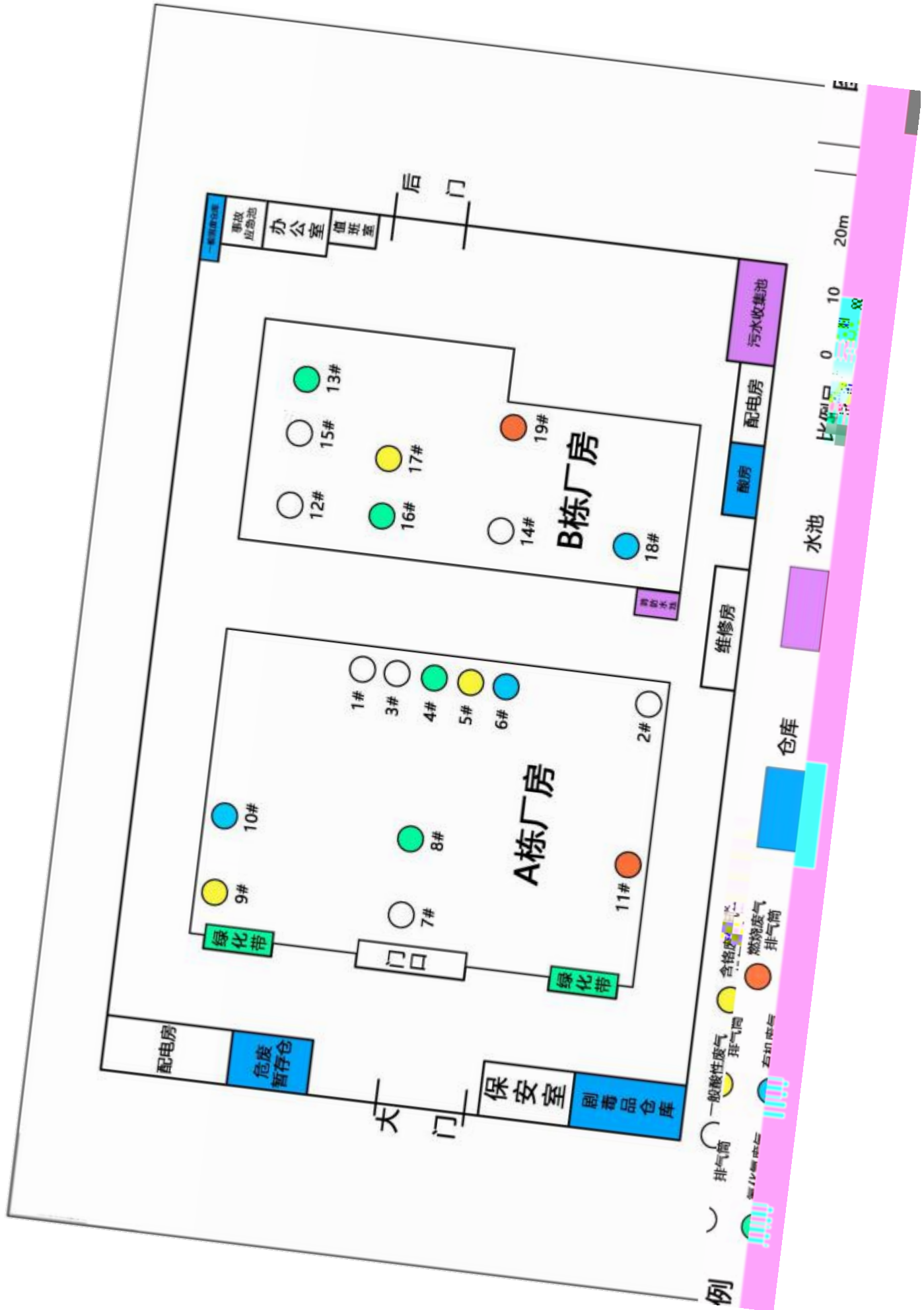

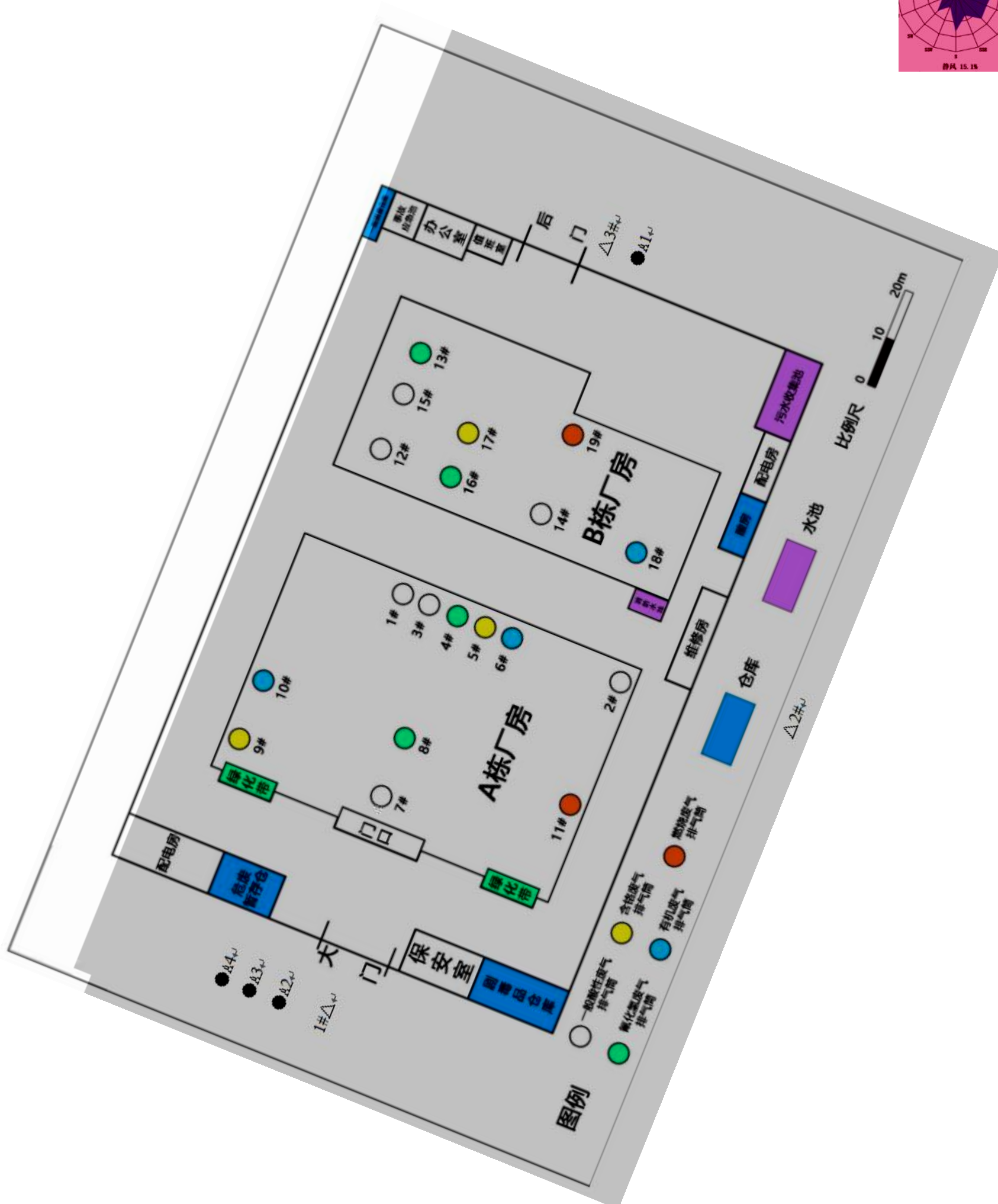
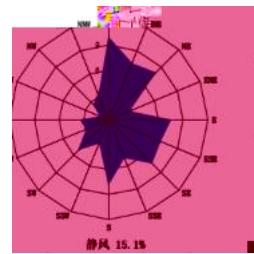



			113 28 9.00 22 42 29.00	15 : 8		3		1 / 1 /	
			113 28 9.00 22 42 29.00	15 : 8		3		1 /	
			113 28 8.00 22 42 28.00	25 : 22		3		1 /	
			113 28 8.00 22 42 28.00	15 : 8		3		1 /	
			113 28 8.00 22 42 28.00	15 : 8		3		1 / 1 /	
			113 28 9.00 22 42 31.00	20 : 15		3		1 / 1 /	
			113 28 9.00 22 42 31.00	25 : 22		3		1 /	
			113 28 9.00 22 42 30.00	20 : 18		3		1 /	
			113 28 10.00 22 42 30.00	20 : 18		3		1 / 1 /	
			113 28 9.00 22 42 31.00	20 : 18		3		1 / 1 /	

			113 28 9.48 22 42 29.88	20 :18		3		1 /	
	1 2 3 4		/	/		3		1 / 1 /	
	YS001		113 28 19.60 22 42 41.11	/	pH	3		1	
		--	/	/	A	/			
		--	/	/	A	/			
		--	/	/	A	/			

1

" " " " "

2.2

2.3

						HJ 693-2014	/
							/
		GB 5468-1991		/		HJ/T 397 GB/T 16157-1996	/
							24
						GB/T 16157-1996	/

							24
						HJ/T 55	
						HJ/T 55	
						HJ/T 55	

		GB/T 15432-1995		0.001mg/m ³		GB/T 15432-1995 /
						HJ/T 55 /
		HJ 604-2017		0.07mg/m ³		HJ 604-2017 HJ/T 55 48h 8h 7d

		GB/T11901-1989		4mg/L		HJ 91.1 GB/T11901-1989	4 :

2.4

a

b

c

10%

10%

10%

d

/

e

2

3

3

3

				65	
				65	
				65	

4

4.1

1.

2.

3.

4.

5.

6.

7.

8.

9.

10.

4. 2

5