

1980









[Redacted]

[Redacted]

[Redacted]

[Redacted]

[Redacted]

[Redacted]

[Redacted]

[Redacted]

[Redacted]

[Redacted]

[Redacted]

[Redacted]

[Redacted]

[Redacted]

[Redacted]

[Redacted]

[Redacted]

[Redacted]

[Redacted]

[Redacted]

[Redacted]

[Redacted]

[Redacted]

[Redacted]





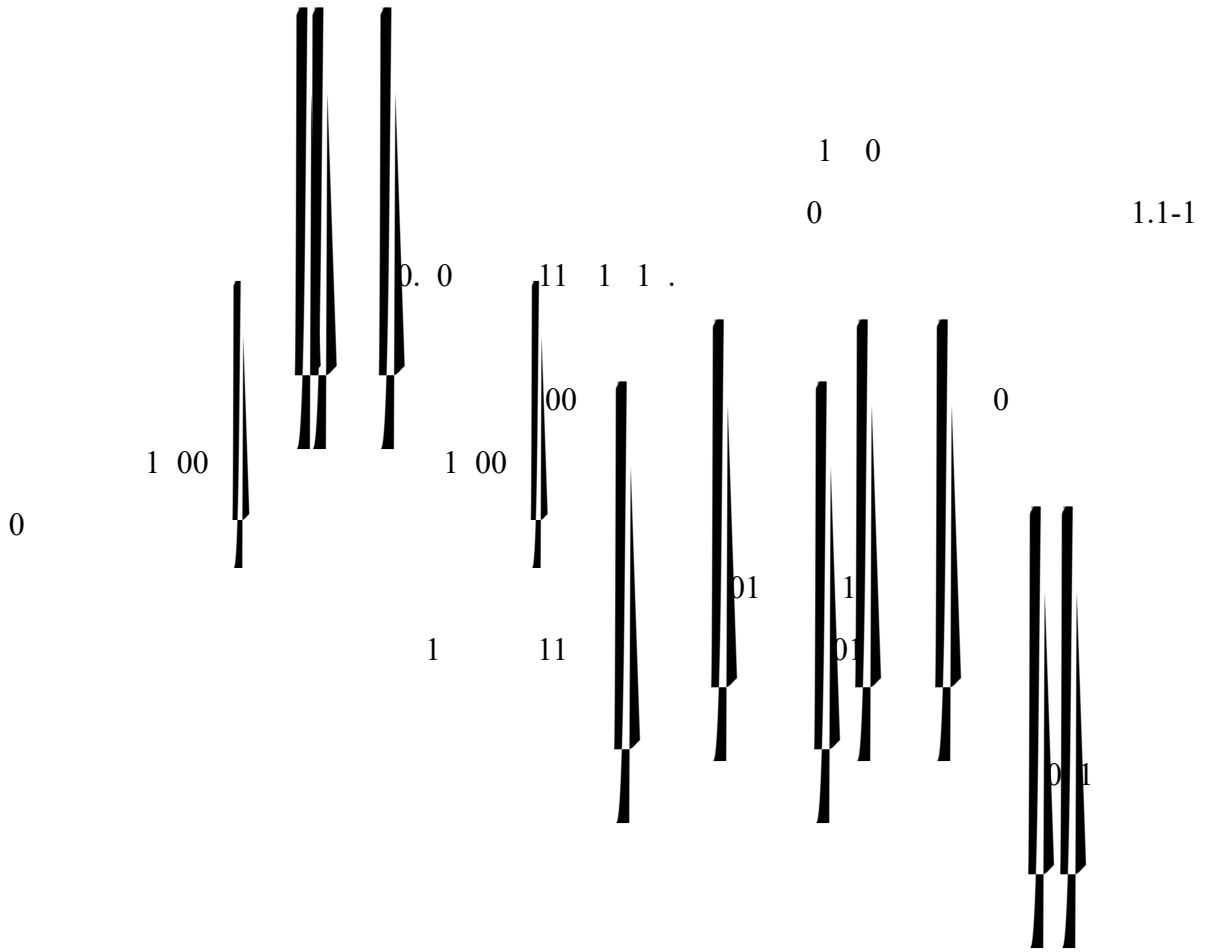

1 0



1. -1

( 1-01 )



# 中山市地图

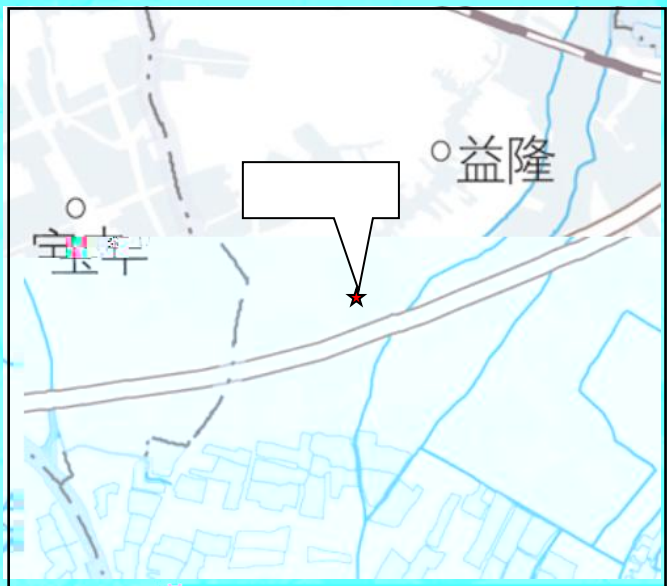
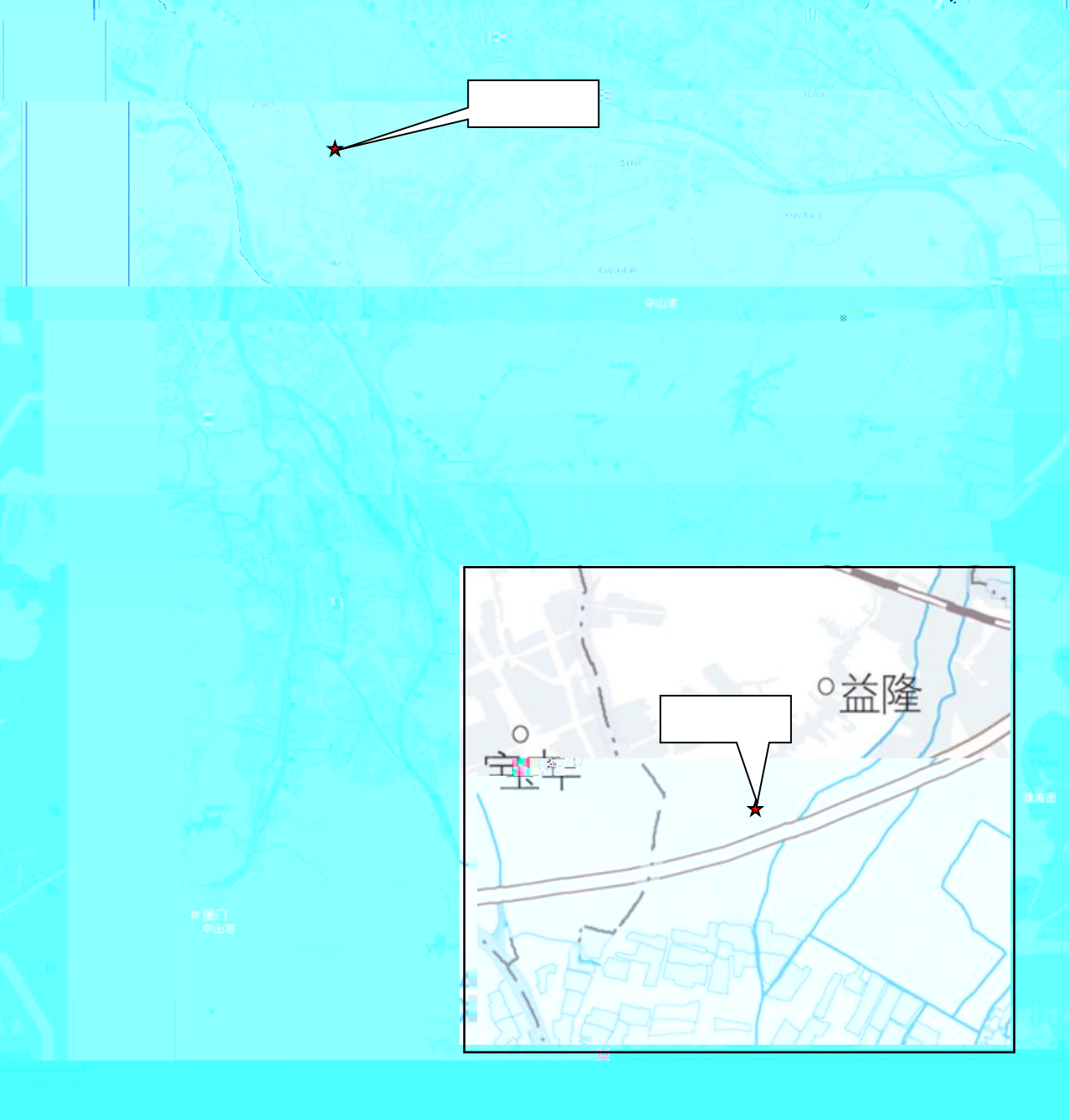
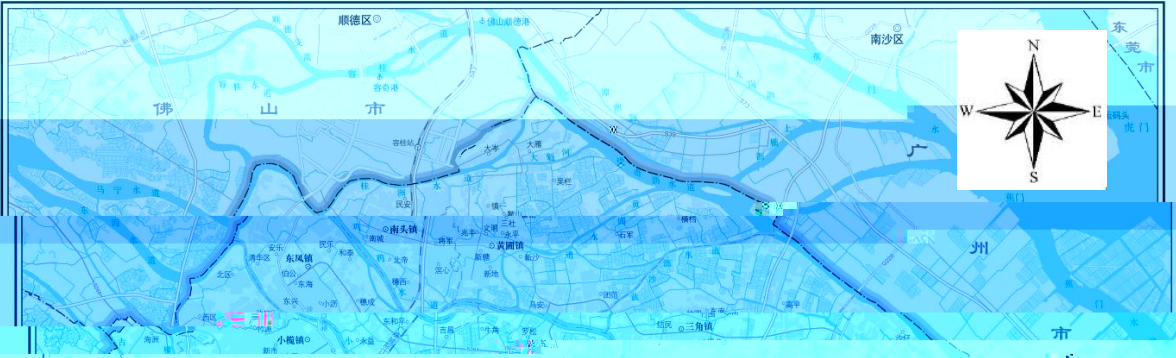

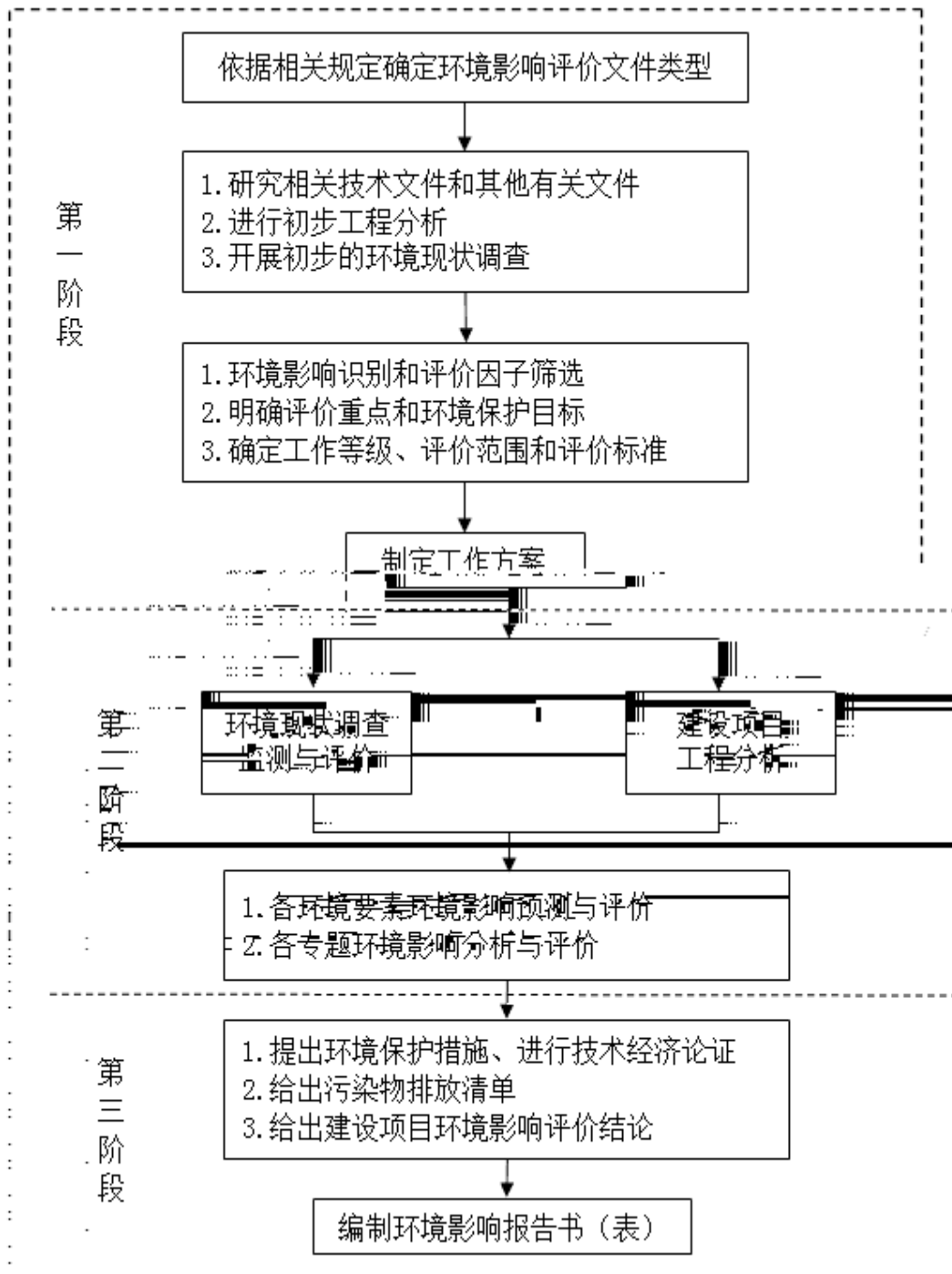

1 0

0

0 1

1

1

0 0  
0 1

		
		 0

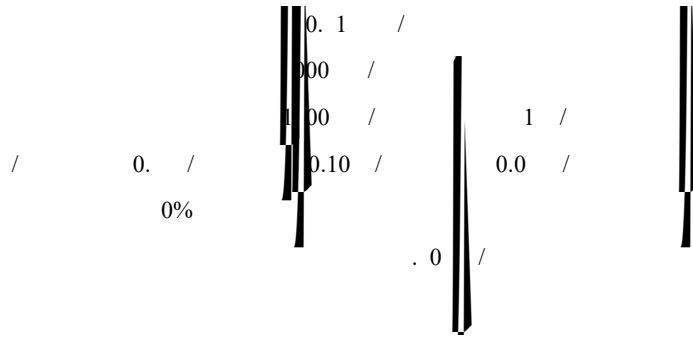

1 0

0

0 0

0 1

( 1 - 00 )



1



01 1









1

/

/

10-01 )

1

# 中山市环境管控单元图（2024年版）

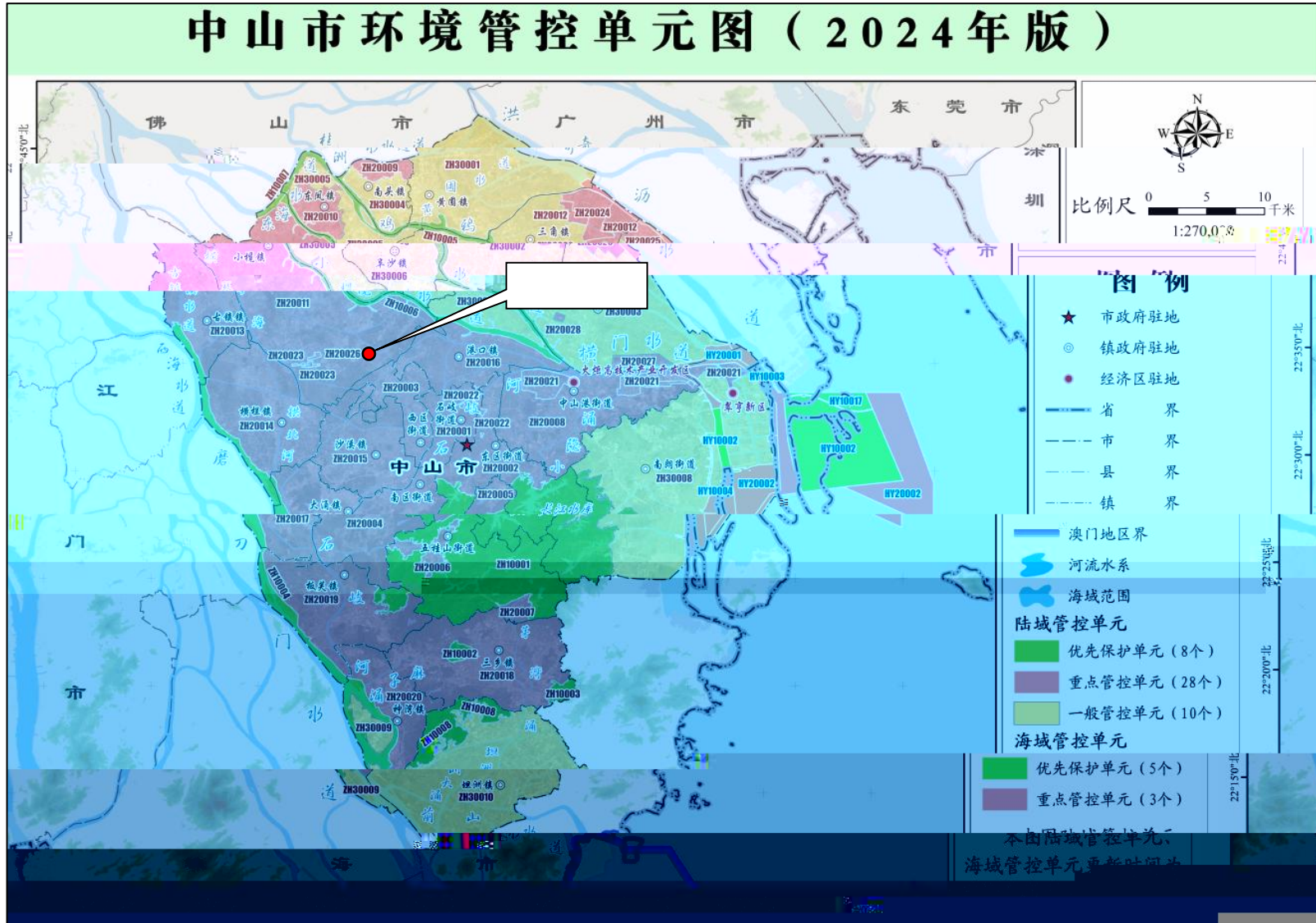



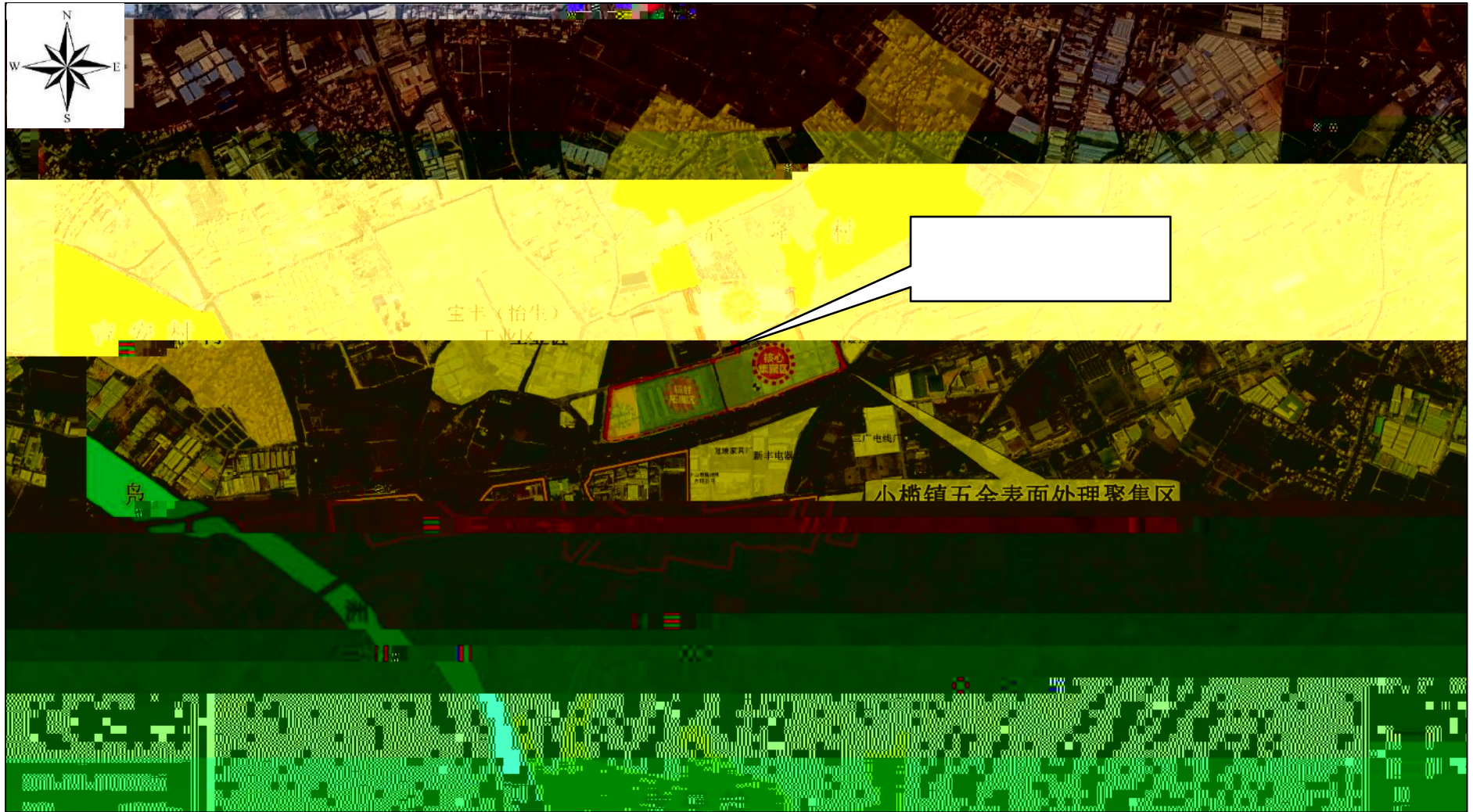

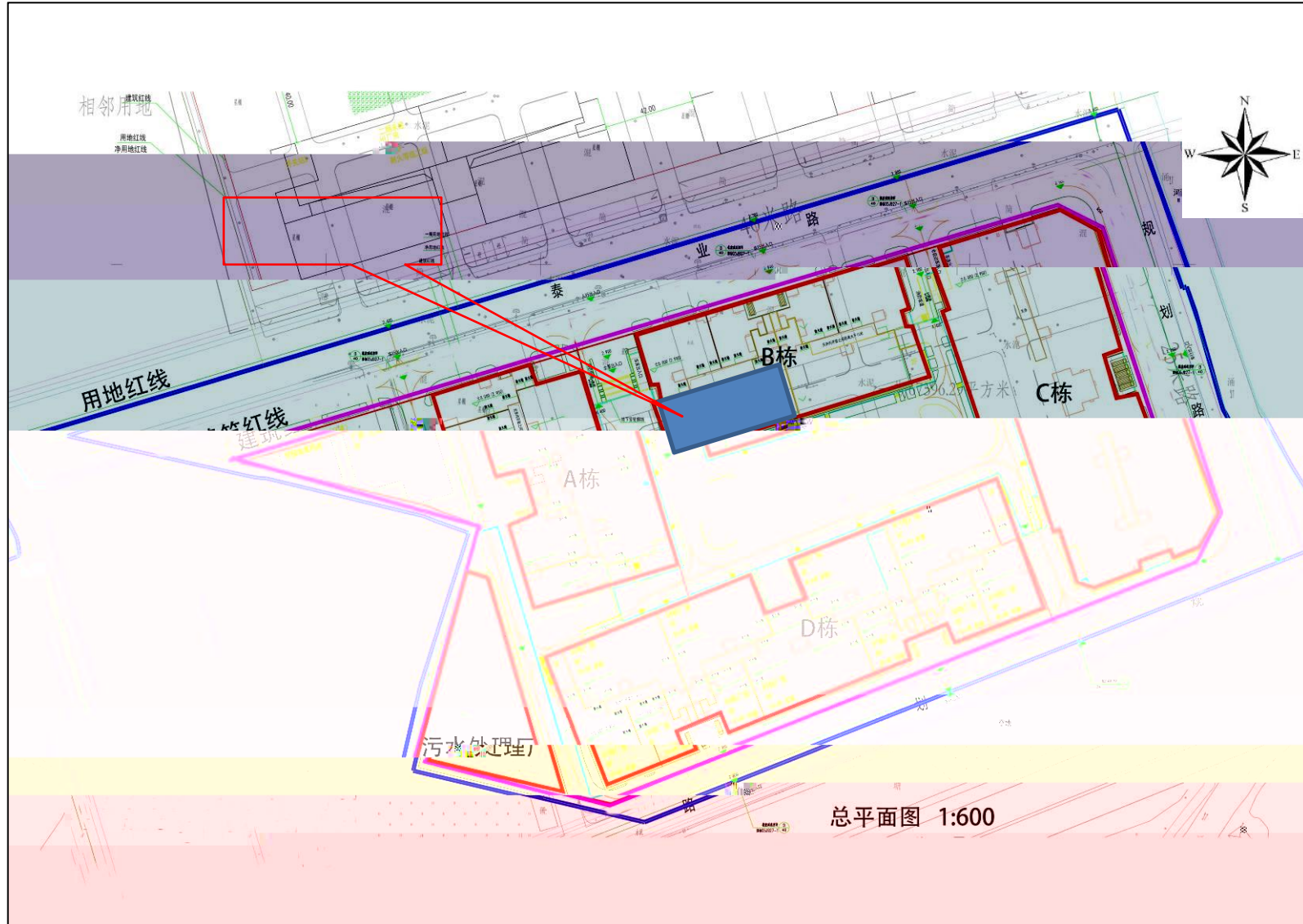

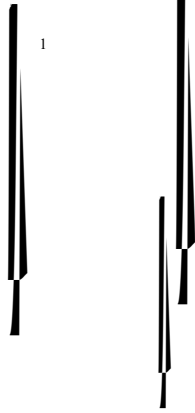

0

1

1

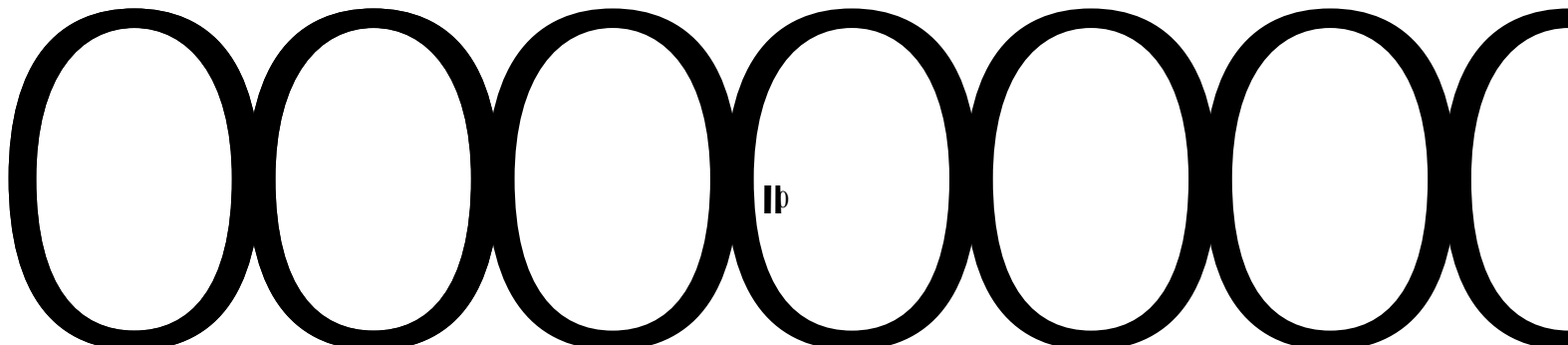
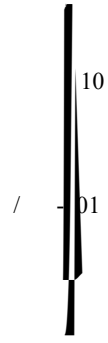

10

~ N t \$ • €

■ ■

~ K

~ M N

W B P E S



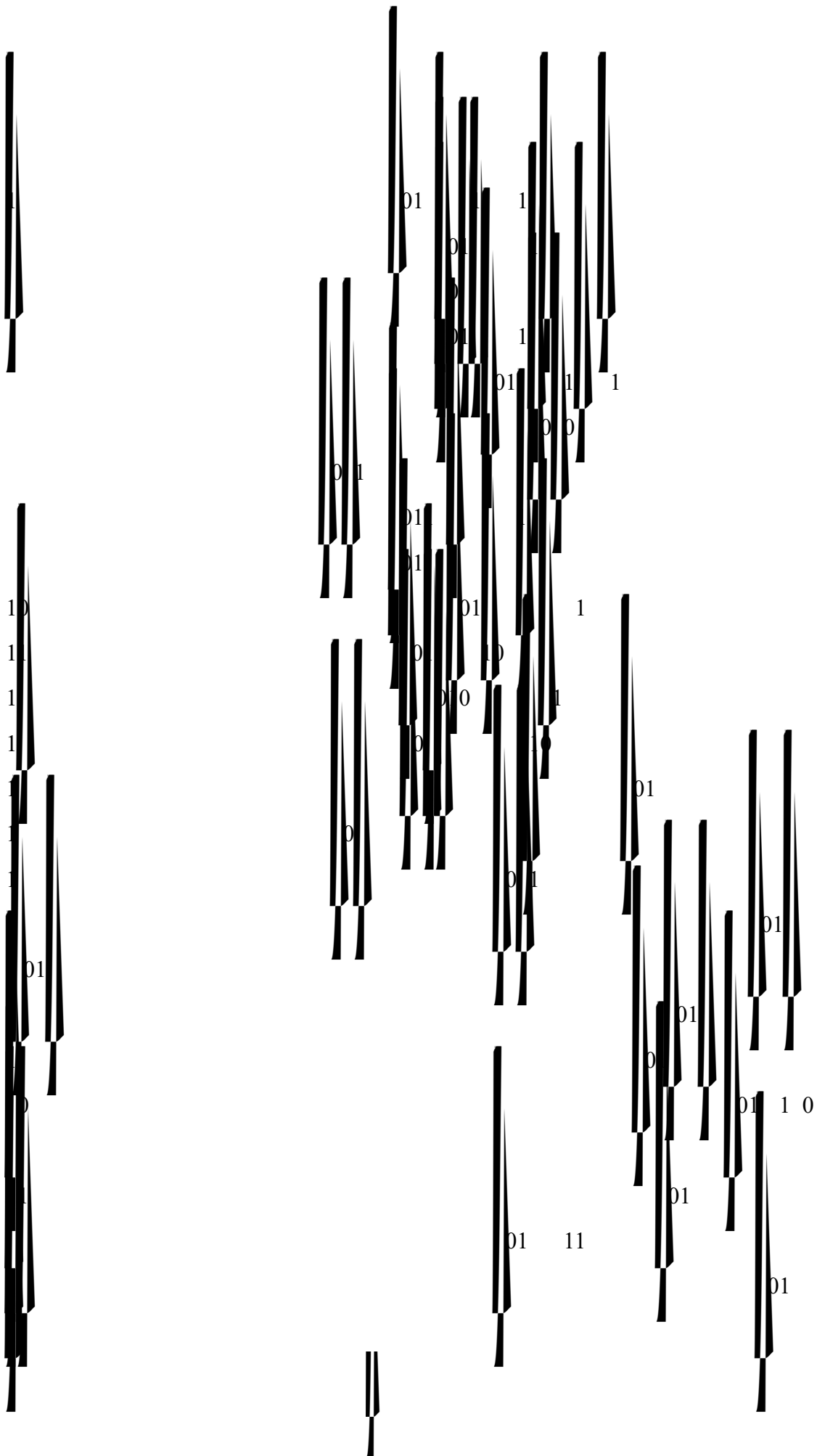

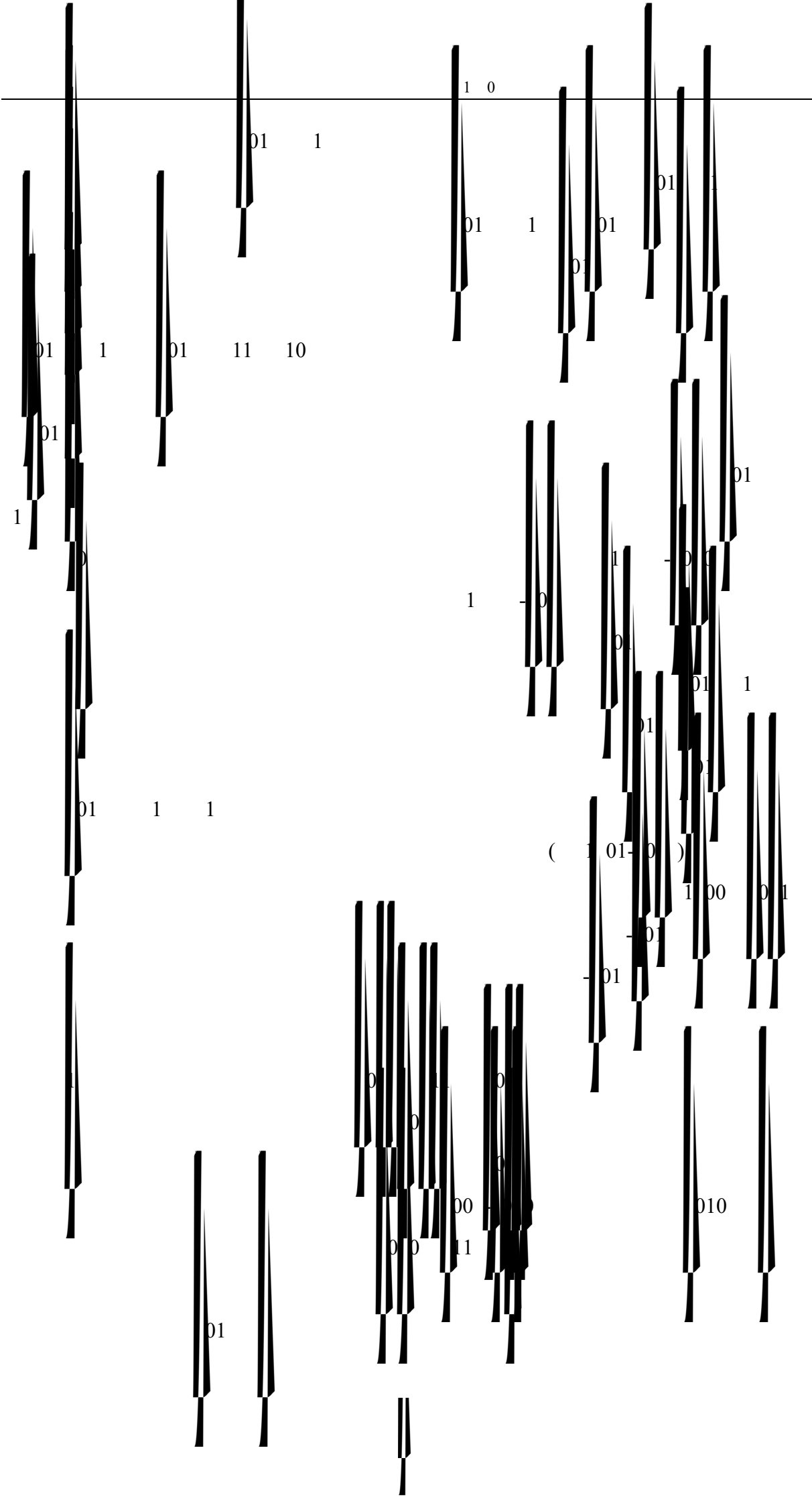

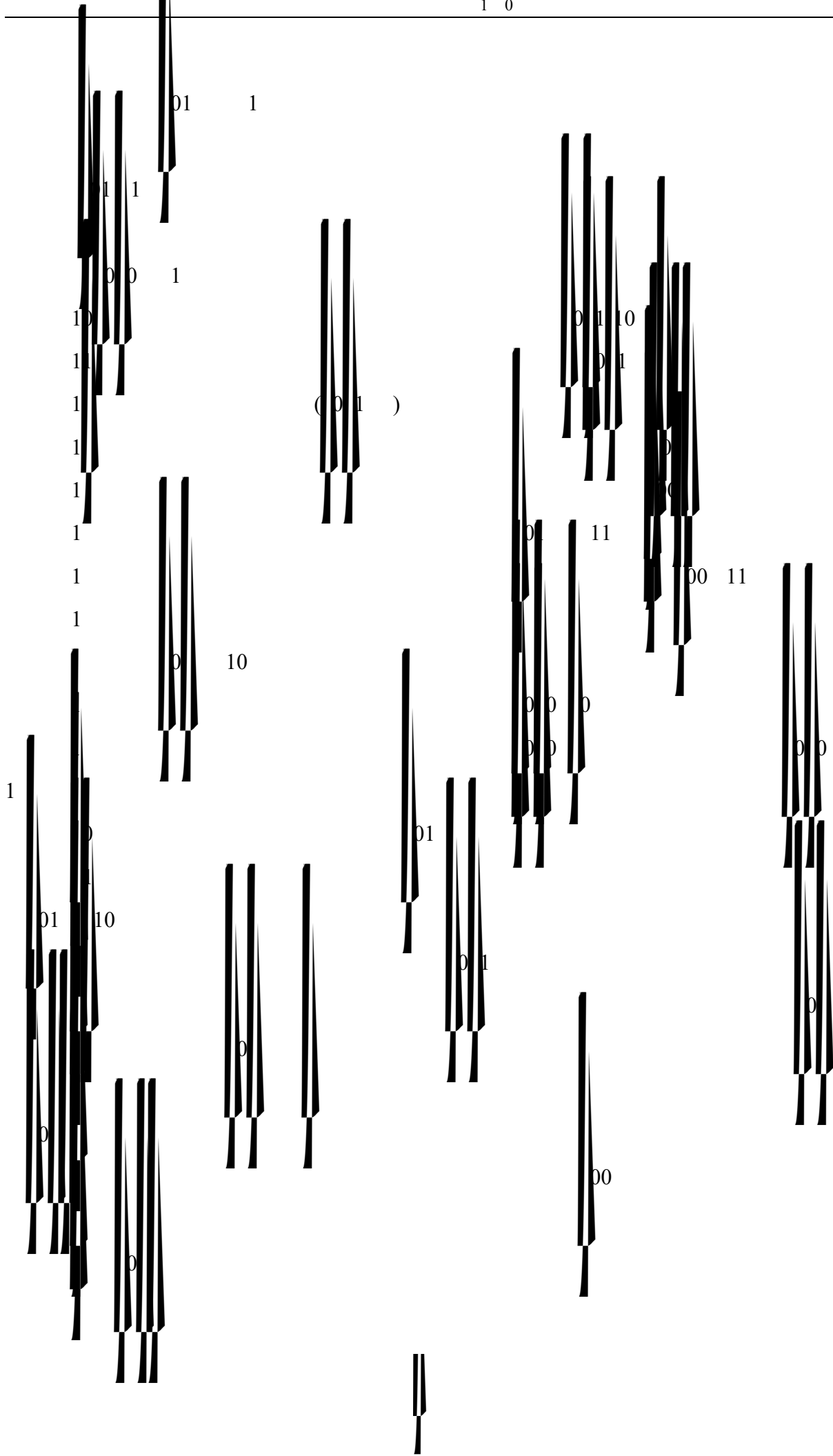

00 01 01 -0 -01  
1 1 01 01 -0 -01 )

(

01 )  
( )  
( )  
( )

( )  
( )  
( )

( 1 -01 )

/ 1 01- 1

( ( -01 )

( 1 0 )

10  
1

0 1

0 000

0011

0

)

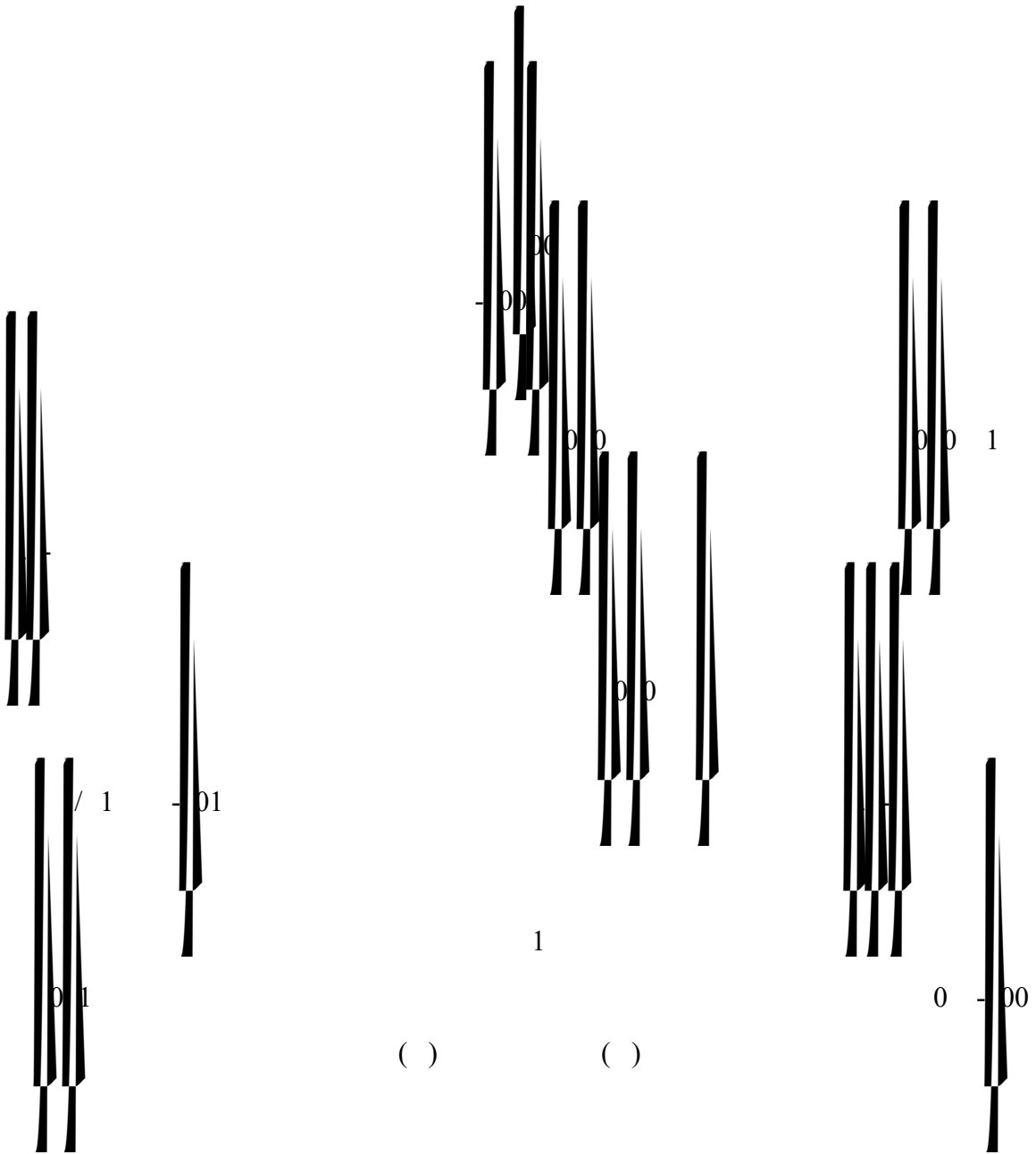

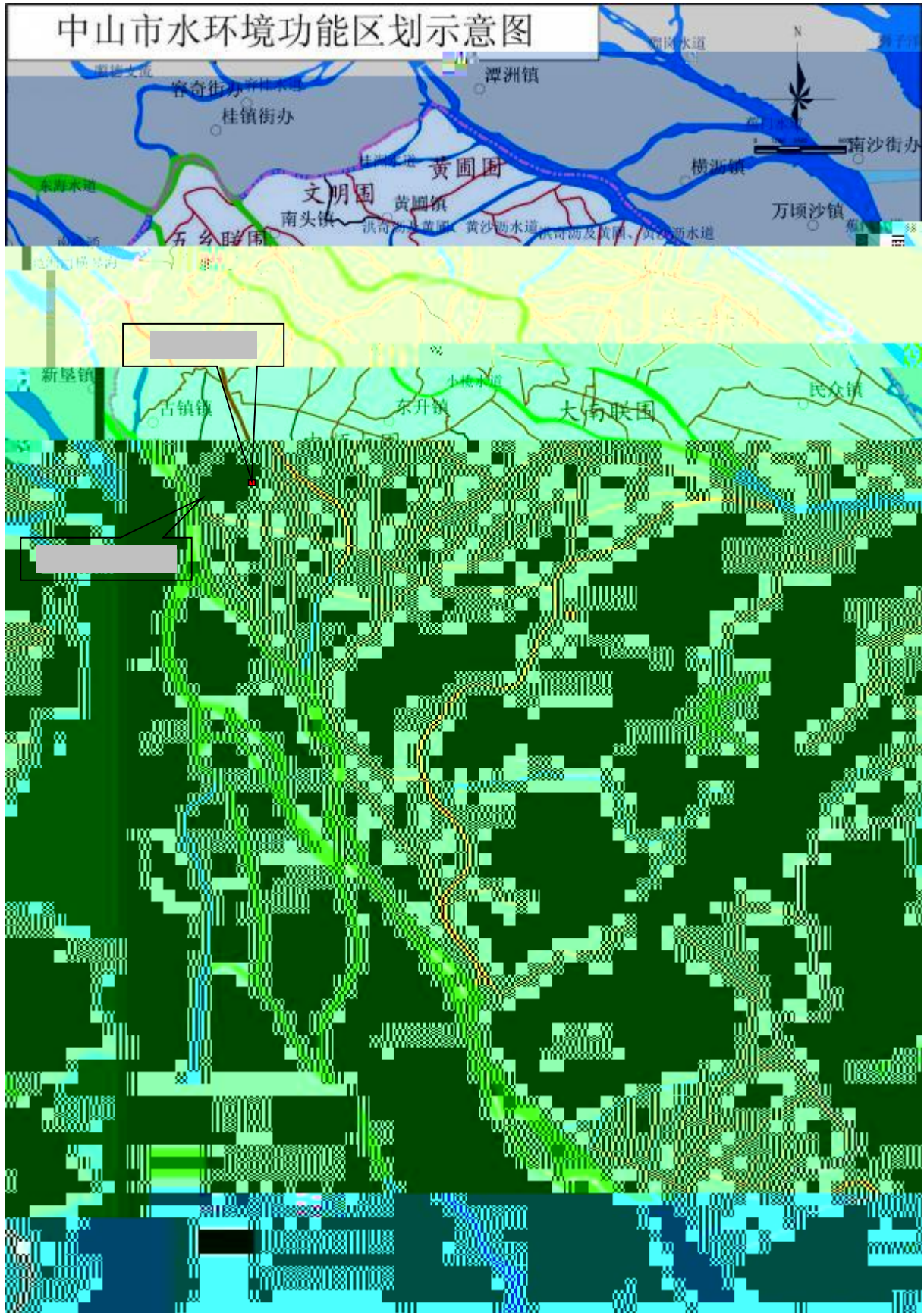

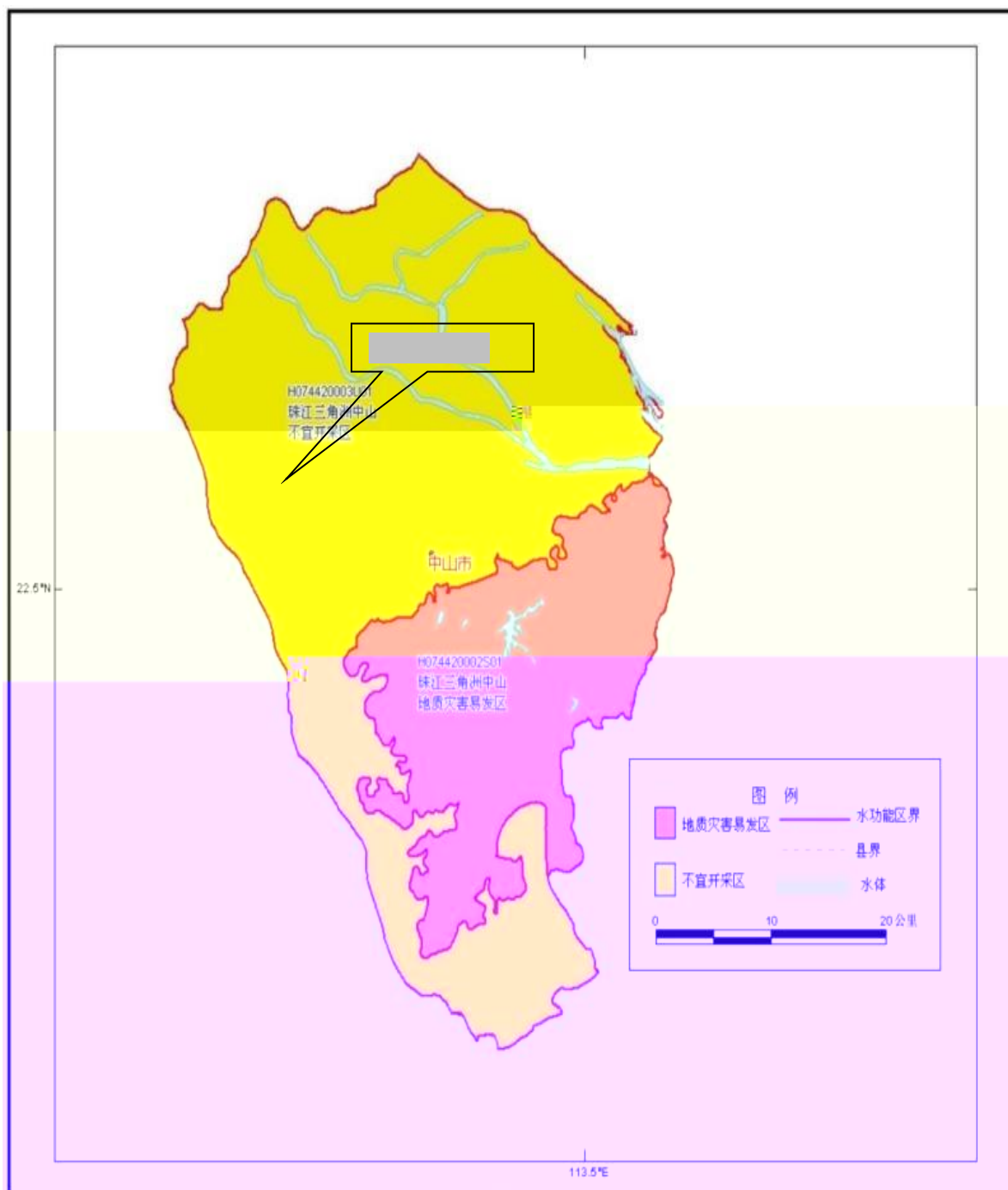

# 中山市环境空气质量功能区划图

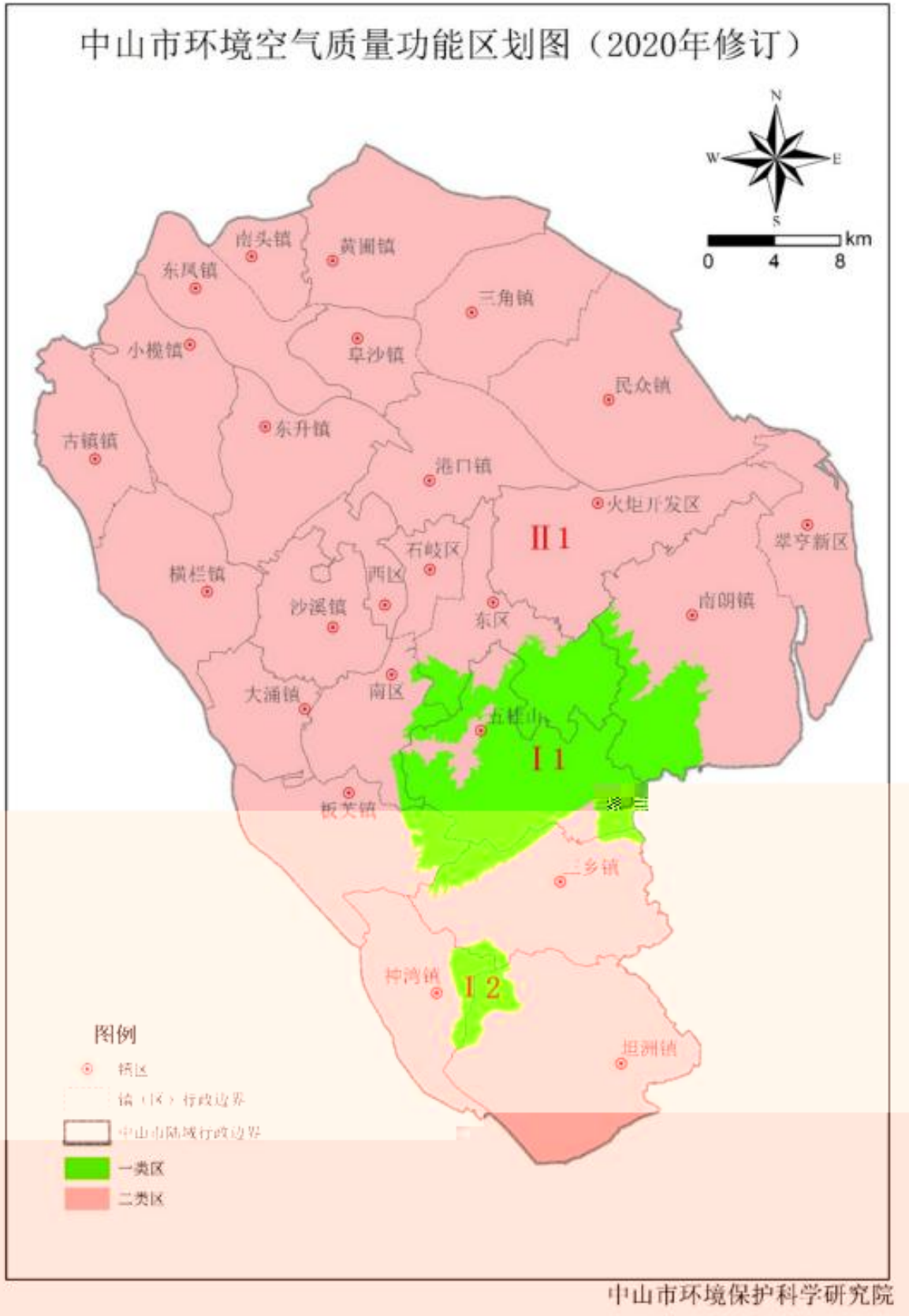

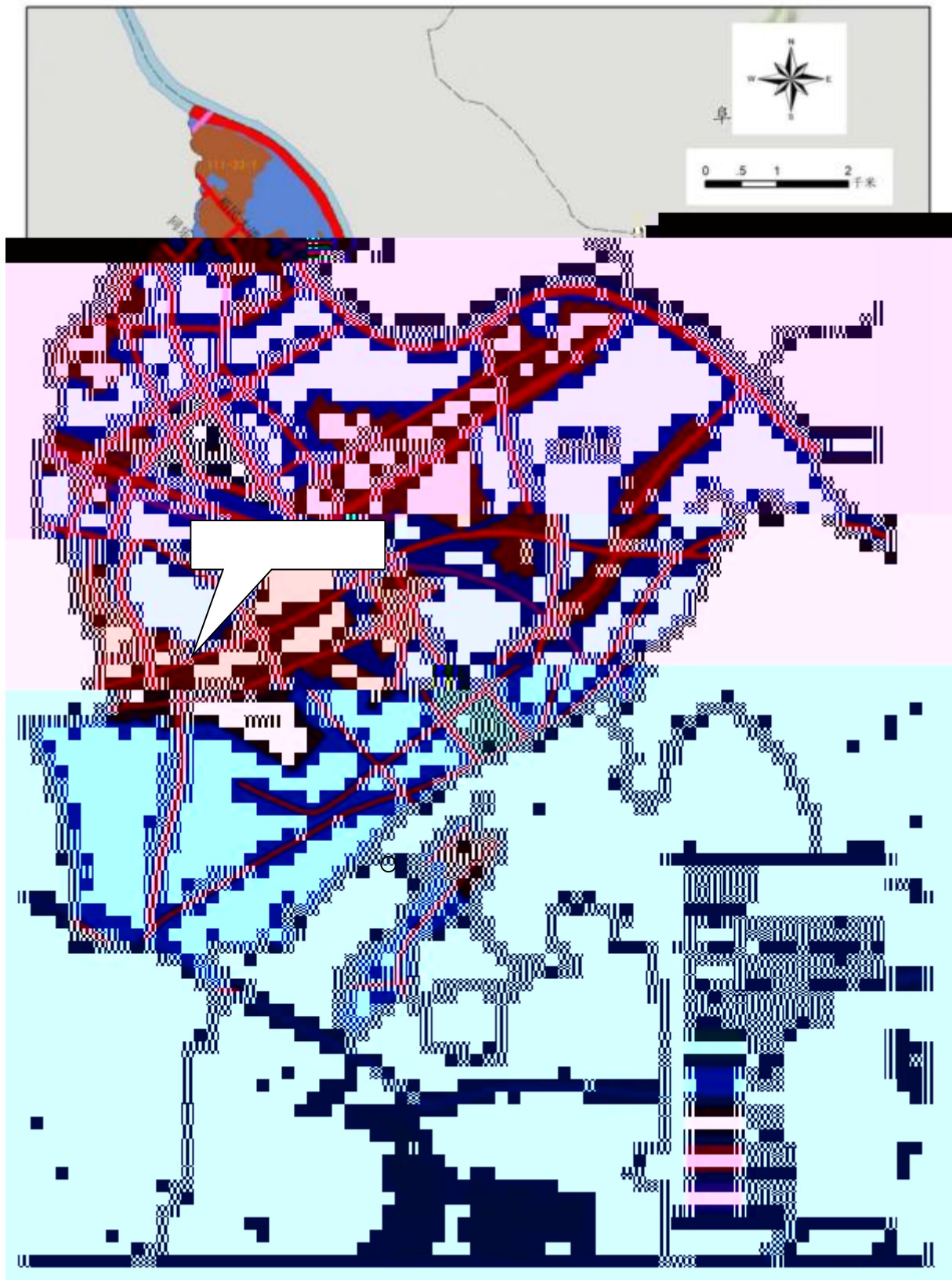

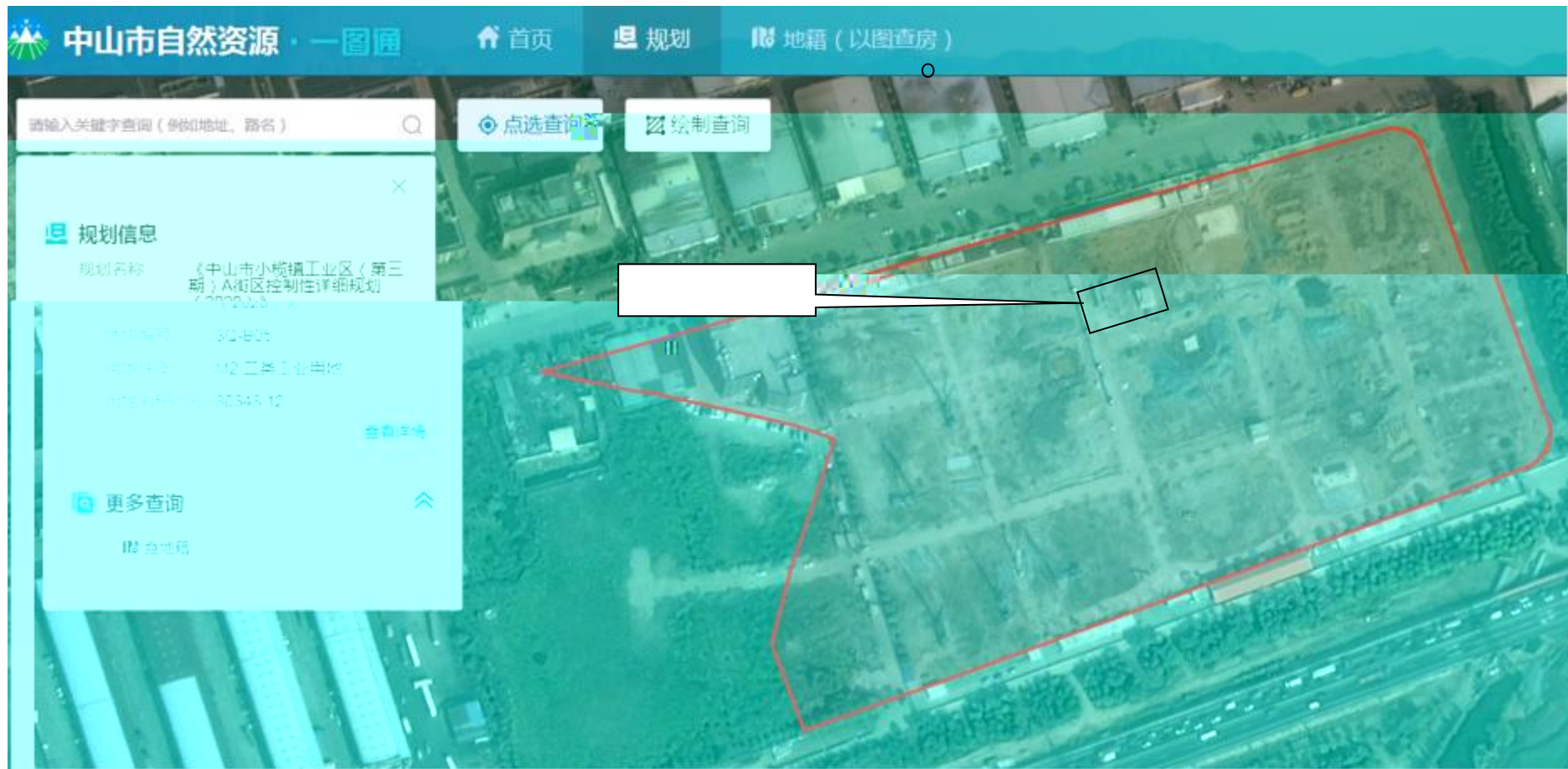

-1

1		0 01
		00 -00
		00 1 -01
		00-01
		0000
10		





1



1

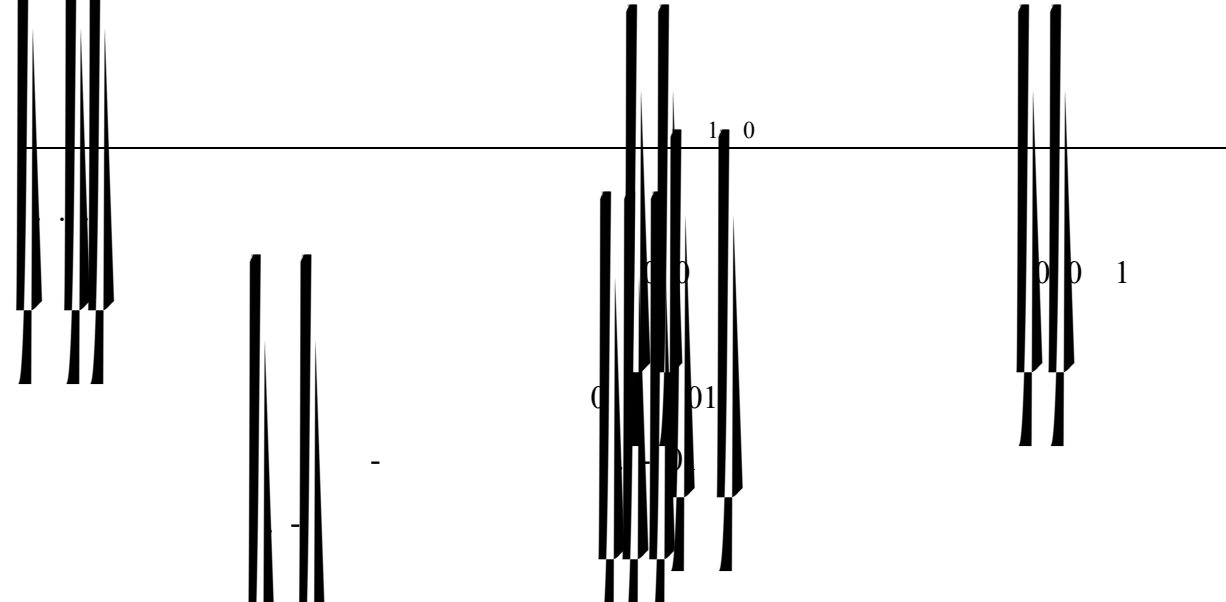

1			0	
		1	1 0	
			00	
			0	
		1	00	
			000	
		1	10000	
			1 0	
		1	00	
	10		0	
			1 0	
			00	
			00	
			0	
			100	
		1	0	
			00	
		1	100	

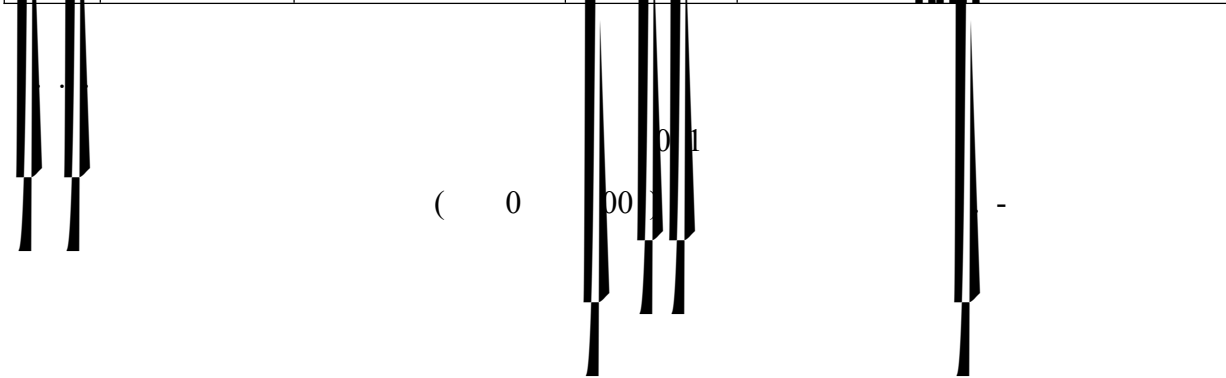

( )

/ 1 - 01

/ ( )

	.
	0
	000
	0
	0
	0
	1. 0
	0.01
	10.0
	1. 0
	00
/100	100
/	1000
	. 0
	0.0
	0.1
	0
	0.00
	0.0
	0.01
	0.10
	0.10
	0. 0
	1

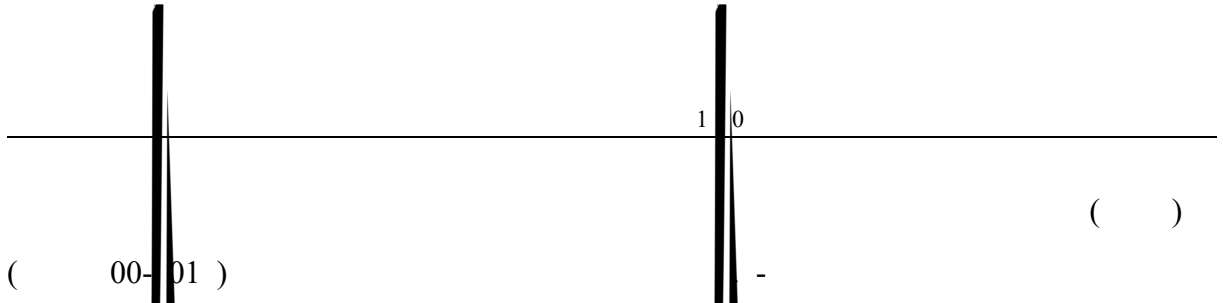



1		0
11		.
		1 000
		00
		00
		0.
10		
11	1,1-	
111	1,1,1-	
1	1,1-	
1	-1,1-	
1	-1,1,1-	
1		1
1	1,1,1-	
1	1,1,1,1-	10
1	1,1,1,1,1-	.
0		
1	1,1,1-	0
11	1,1,1-	0.
		0.
		0.
		0
	1,1-	0

||  
0  
1  
||

1, -

+

||  
0  
1 0  
1 00  
0  
0

1		00	
		00	
	-	/	
			
		/	
		00	
		-	
		100	

1 /  
# 100 10000 0 1 0 00 0 -- 000 -- 000 -- 0 -- 10

# 0 11 11 1 0 -- 1 10 11 -- -- 10

# 0 000 000 0 00 -- -- 000 -- 10 00 -- --

#

	/														
	0														
#	100	1000	0	0	0	--	0	00	--	10	--	--	--		
	00														
#	1000	0	0	0	--	--	00	10	0	--		--			
	1 0														
#	100	1000	0	1 0	1 0	00	--	00	--	10	--	--	--	10	
	0		#												
#	0			#				8#				2#			
	1	0	--	--	--	--	--								



	-	
	0	
	0.	
	1	
	0.	/1 - 01
	0.1	
	0	
	10	
	0	
	0	
	.0	/ - 001

..

/ - 001

1

	( / / )	
	1.	( / - 001)
	0.1	
	1.0	/ - 001

0  
1 0

11.

1 001  
1 00 00

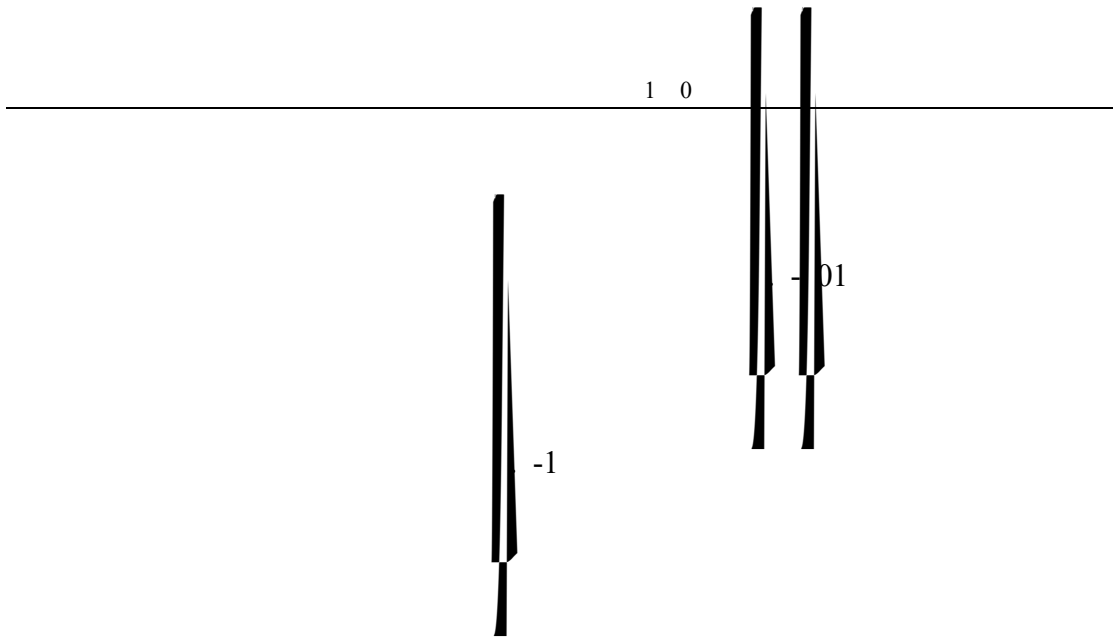

			/ /
			/
		0000	00000
		00	000
			--



1

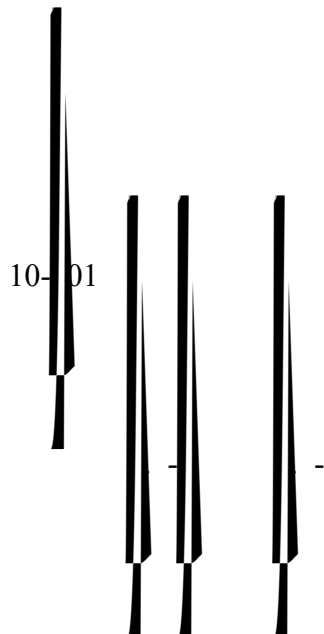



10-01

10

10

01

10%

10%

/ 0 100%

0

01

%

/

-

	10%
	1% 10%
	1%

( 01 )

/	/	
		//
/		.
/		-1.
	/	0
	/	/
	/	/

// . . /

(11 . [REDACTED] 0 )

(11 . [REDACTED] )

(11 . [REDACTED] 0)

(11 . [REDACTED] 11 )

1	0- 0			1 1 1 1	0.1	0.	1
1 1					0.1	0.	1
					0.1	1	1
				10 11	0.1	1	1

				( )	( )	( )	( / )	( )	/		/	
		/	/	-1		1.0	1 .					0.0
												0.01

				/							/	
												0.0
	1	11 . 1 1	0	. 0						10		0.0
												0.0 0
												0.00

1

. + + +1.

1.

		( / )	( / )	(%)		10% ( )
		00.0	0.1	0.0		/
		00.0	0.	0.1		/
1		00.0	0	1. 0	1	/
	10	0	0		1	/
		00.0	0.	0.	1	/
		00.0	11.0 0	.	1	/

. % 10%

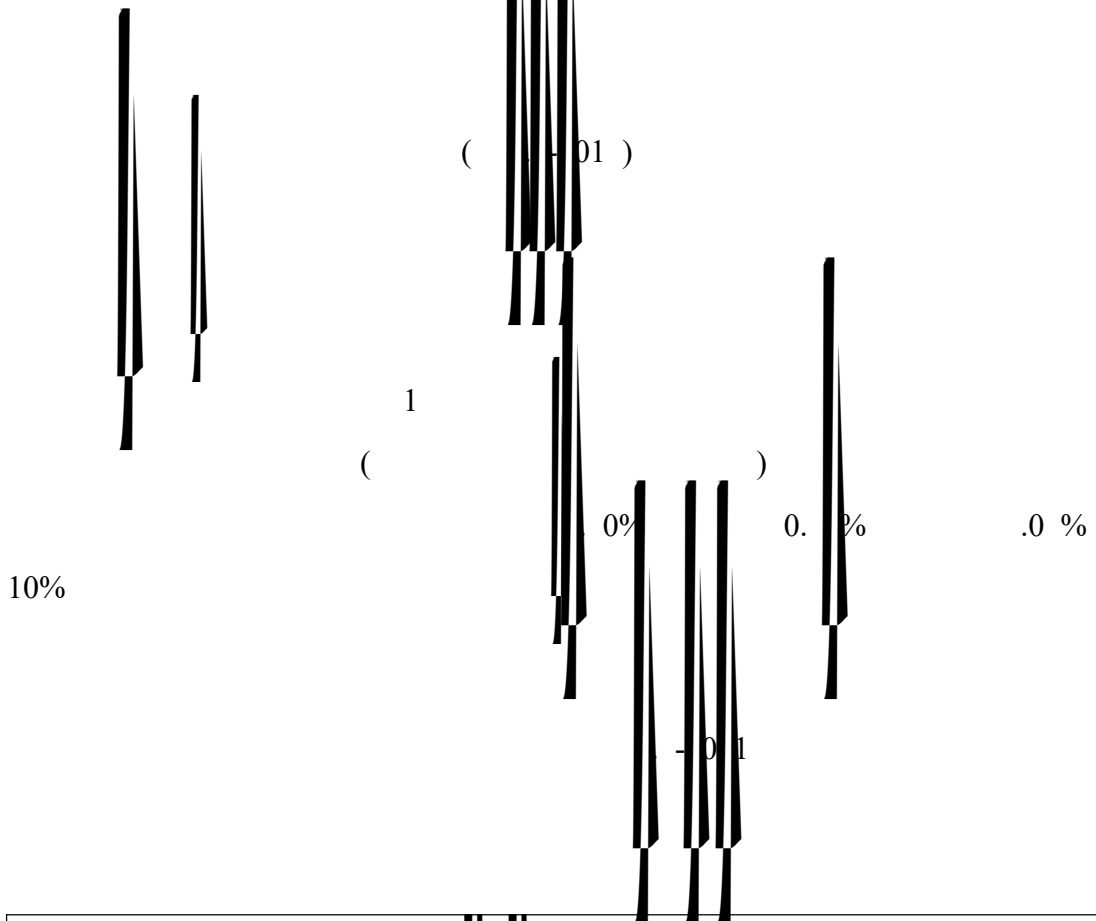

- 00
0 0 ( ) ( )
0 1    ( ) ( ) ( )
0

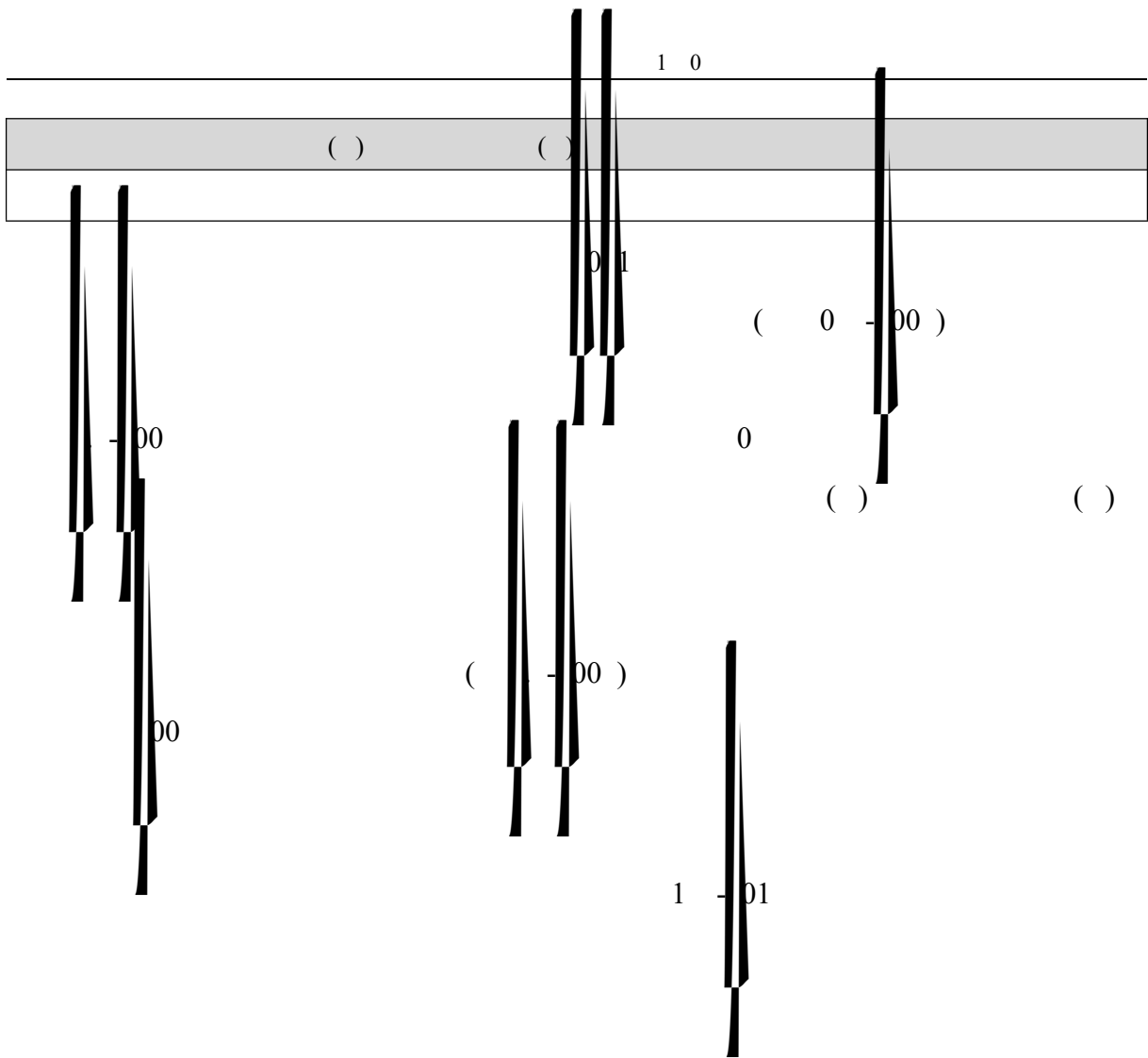

	+			

( ) ( ) ( )

1.

1			- -	0.	.	0.035
			- -	.	10	0.730
			- -	. 0	10	0.851
			/	0.1 1	0.	0.528
			/	0.00	0.	0.013
			/	. 0	10	0.370

10000 /

10

10000 /

. 0

1

10

.

1

1

+

1

+

1

+

1



1 0

- 01

00

- 01

00

1 - 0

--	--	--



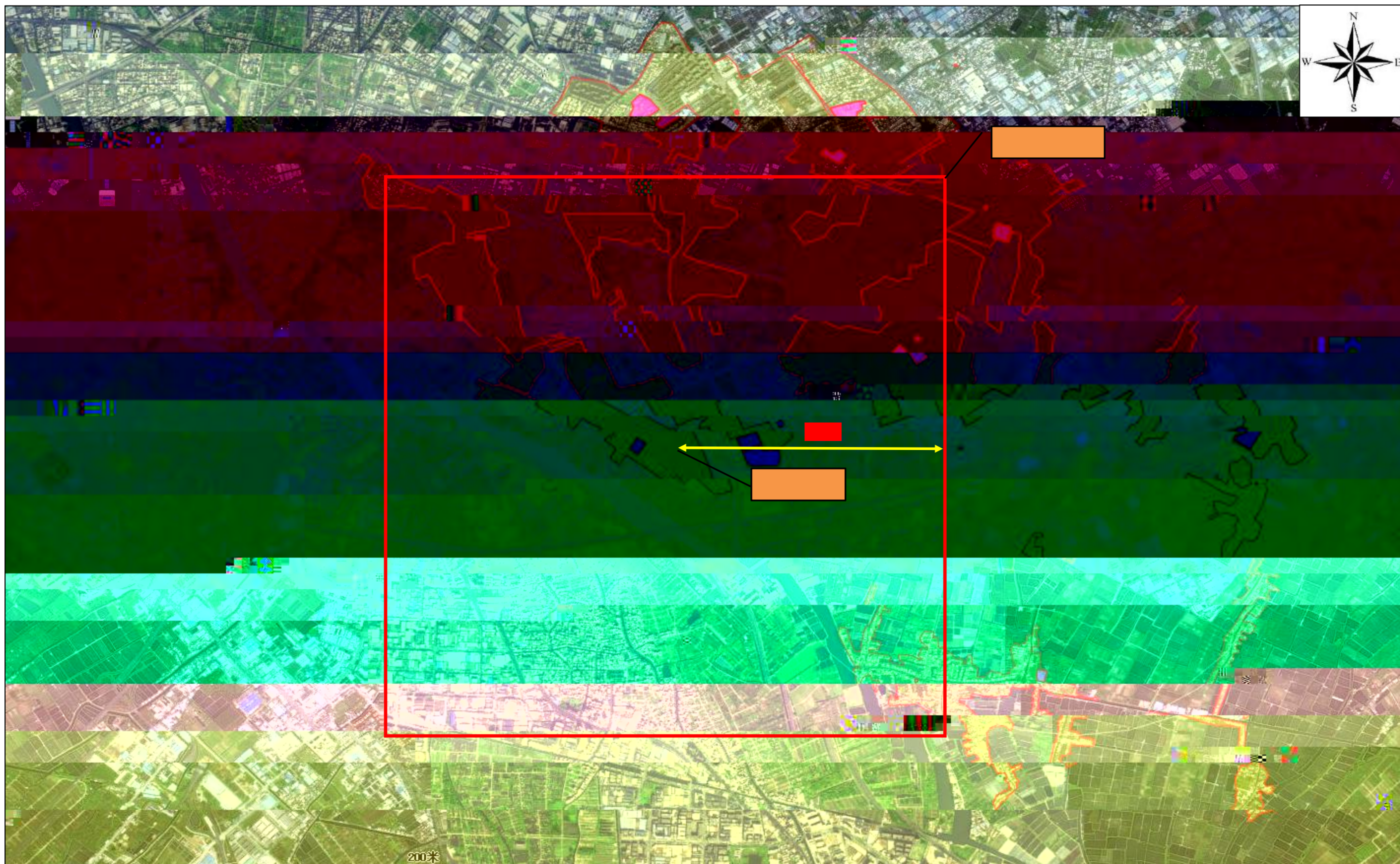

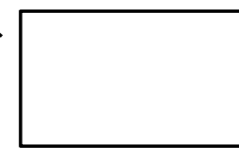
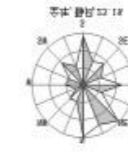
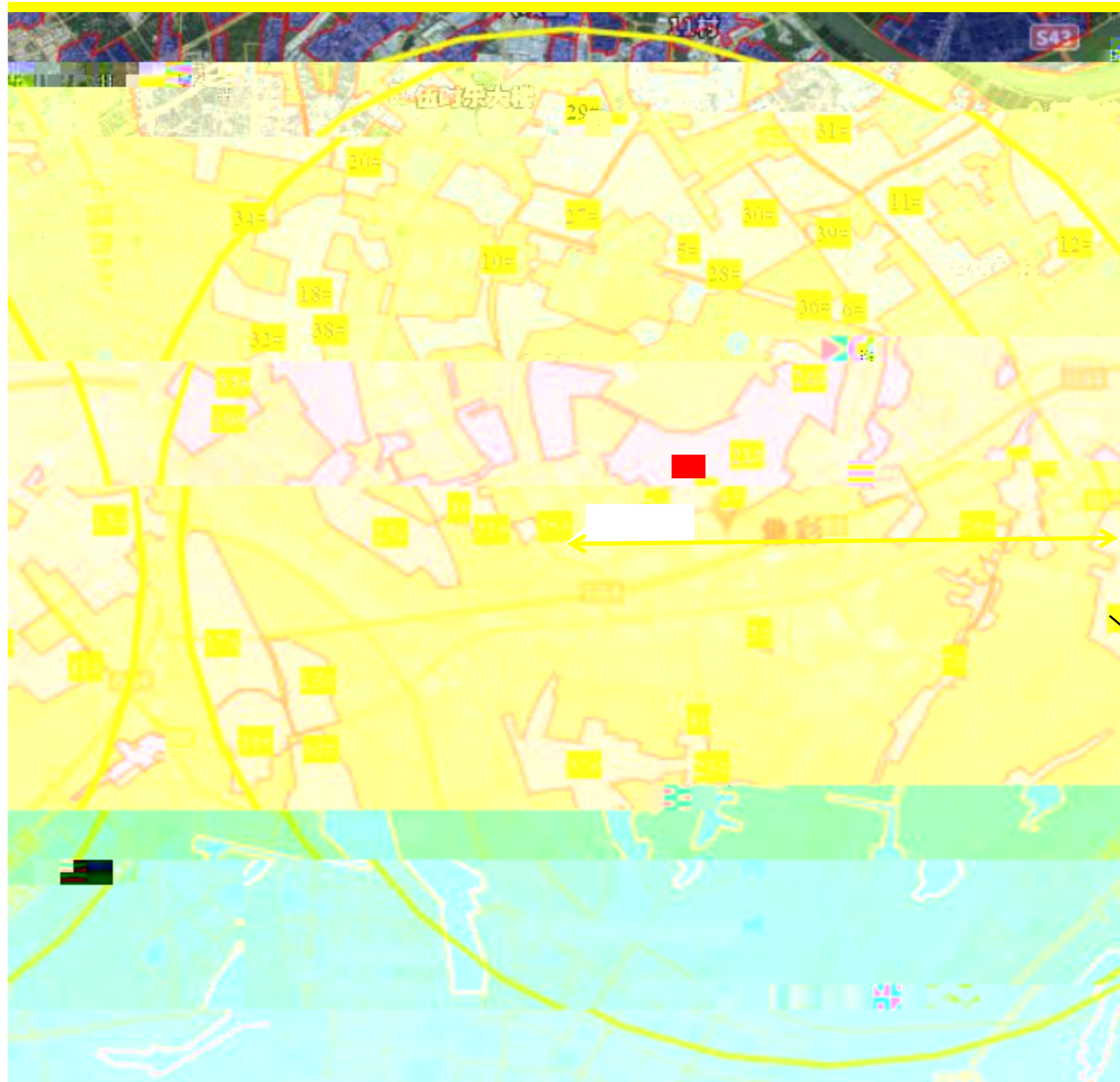

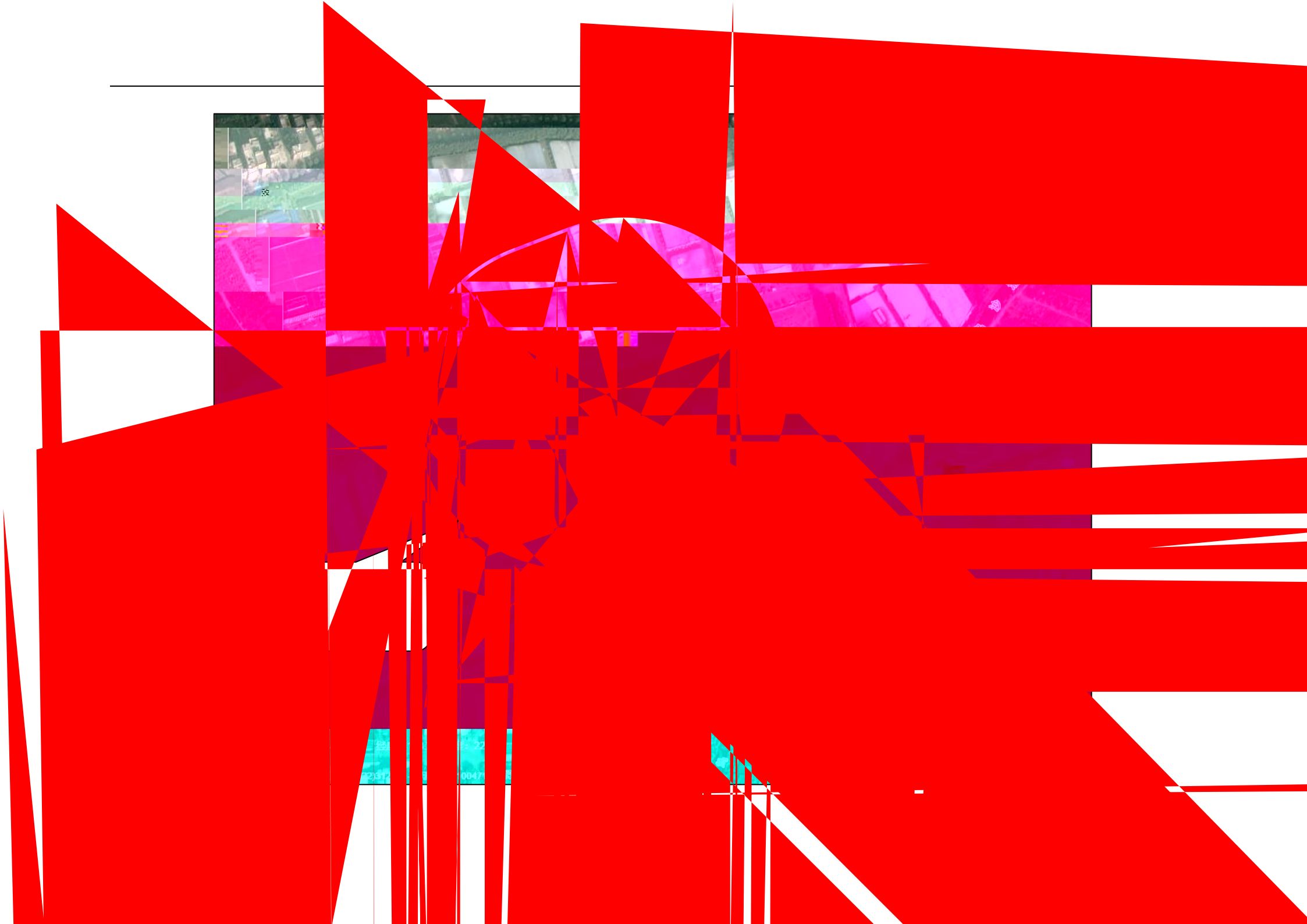

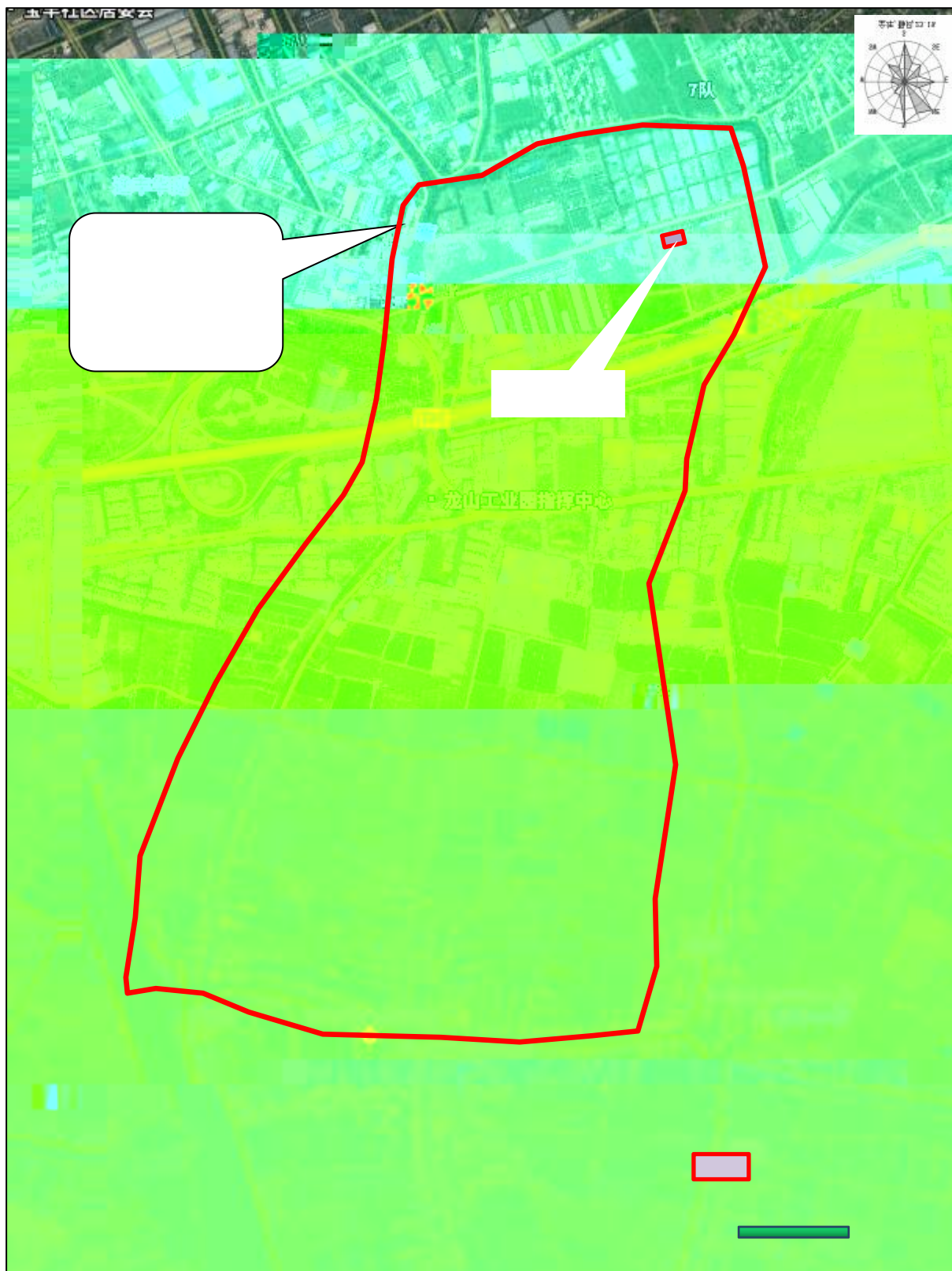



-1



-1

1		11 . 11	1111		0	000	
11		11 . 1	1111	1111	0	000	
		11 . 1	1111	1	0	000	
		11 . 1	1111	10	10 0	000	
		11 . 0	1111	11 0	11 00	10000	
		11 . 1	1111	0	1 0	000	
		11 . 11	1111	11	1 0	000	
		11 . 1	1111		11 00	00	
10		11 . 1	1111	1 11	0	000	
11		11 . 1	1111	1	00	000	
111		11 . 0	1111	111	11 00	1000	
1		11 . 1 11	1111	1	0	000	
1		11 . 0 0	1111	11	00	000	
1		11 . 1	1111		1 0	1000	
1		11 . 11	1111	0	0	000	
1		11 . 11	1111	0	0	000	
1		11 . 0 1	1111	0 0	000	1 00	
1		11 . 0 1	1111	1	0	1000	
110		11 . 11	1111	111	00	1000	
111		11 . 1	1111	111	11 0	00	
1111		11 . 0	1111	0	1 00	11 00	
		11 . 1	1111		11 00	00	

		11 . 0	0 0 0 0		1 0	0	
		11 . 10			00	0	
		11 . 0		01	00	1000	
		11 .		1	00	00	
		11 . 0 0		1	00	00	
		11 .		0	00	00	
0		11 . 10 1		1 0	00	000	
1		11 . 1 1		1 1	00	1000	
		11 .		0	000	00	
		11 .		0 1	00	00	
		11 . 1		1	00	000	
		11 .		1			
		11 . 1 0		0	1 0	00	
		11 .		1	00	00	
		11 .		0	00	00	
		11 .		1	00	000	
0		11 .		0	00	00	
1		11 . 1 0		1	0	1000	
						00	



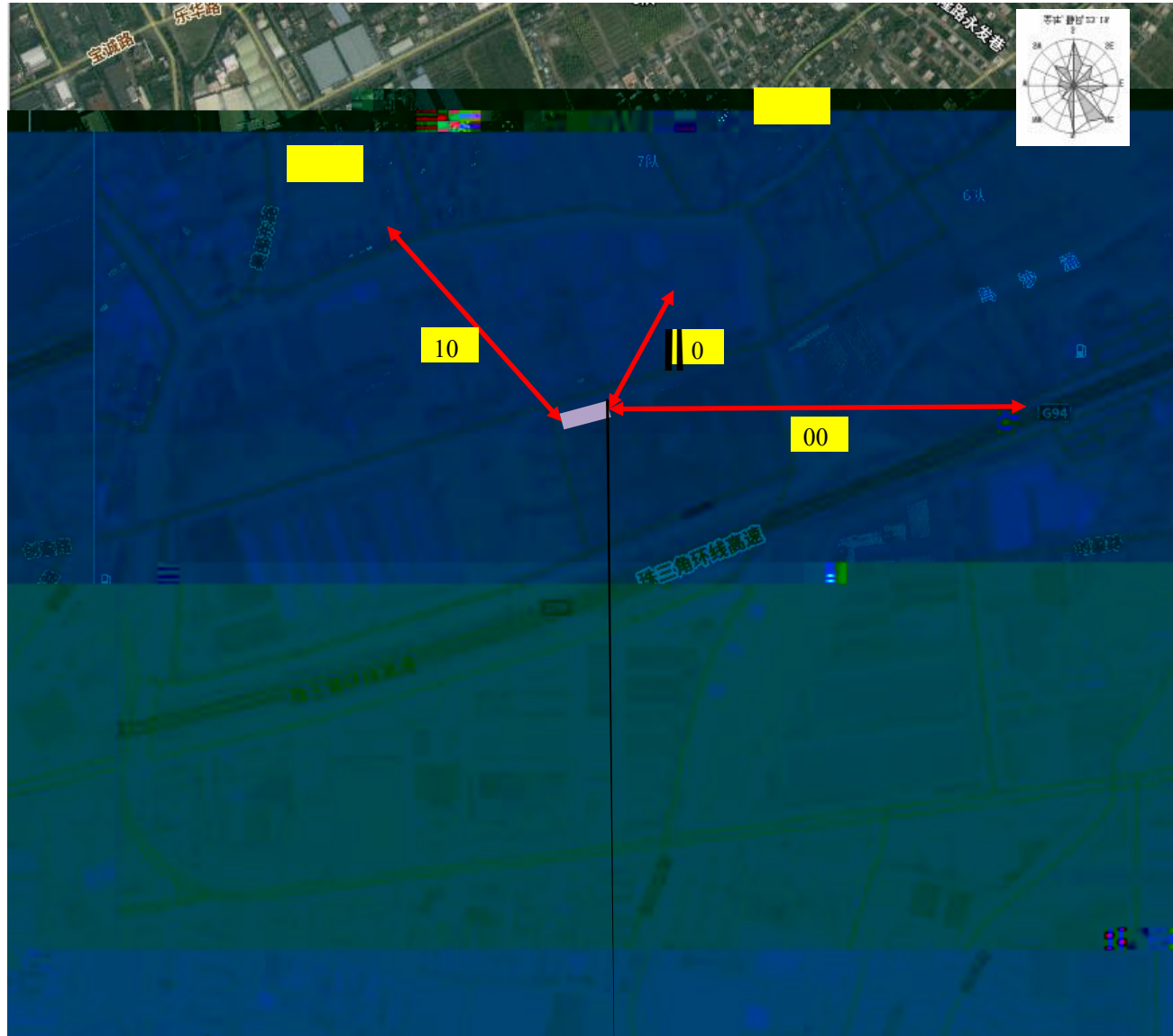

.1-  
1.1-1  
0  
0  
0.0  
11 1 1 .  
01  
1 0  
0

10  
1  
1  
1  
1  
1  
00  
10  
0  
0

1 00

1 00

1

0



				0 0

	01 /	1 /	1 00 /	1 / 01 / 0 . /
				1 / 1
		0		

1

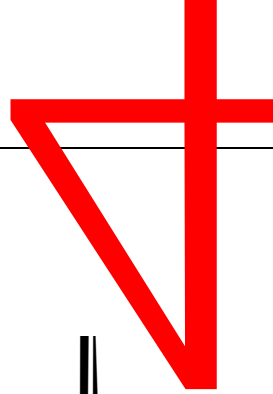

1 0

1

00

00

0.027

0.4

0.0



c



									/		
1				000*1000*1 00		0		1 0	1 .	0.0	.

		/				
1		184.8	0.	0.0		8.32
/ / ×						

						(%)
1		.	.1	0.0 1	.1 1	.

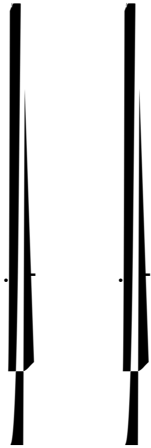

1%

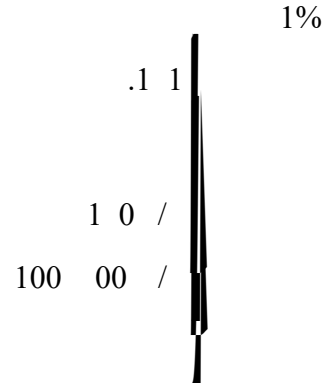

1%

						/		
1			0.0	1	1 0	1	.	000

1			00	10	/		/
			1 00	0	/		/
			0	10	/		/
				10	/		/
			1	1	/		/

.1	1		/	/
1.	0.		/	/
1.0	0.		/	/
1.	1		/	/

10

>.B3%04

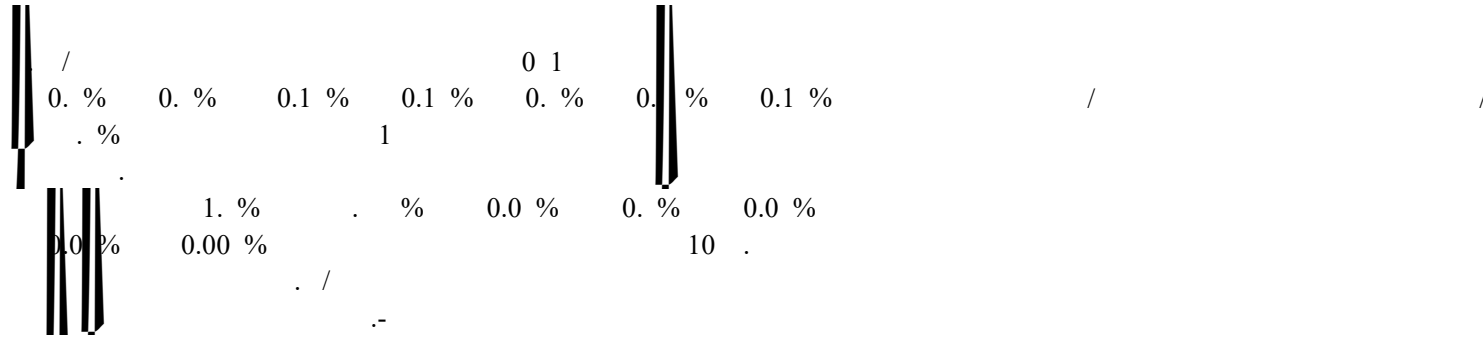

02æ'0'0' 00 0æ□ □ ∑ w  
 e . m  
 % ∑ p  
 ∑ c  
 p p p . ∑ 0 ∑ c \ w j  
 w  
 08\ 0  
 0



Ž . Ž

	1.		
	% 1 %		
1 10-	0.1 ( ) 1 . 1 0 ( 1) 1 0.01	( )	/
-	. (0 ) % ( 1) 1. .01 ( 1) 1	( ) ( )	/
-	0. / ( ) / 0 .00 ( 1) 1. ( ) .	( )	0 1 0 / ( ) 0 / ( )
-	0.1 (1 . ) % 10. ( 1) 1. 0.0 ( 1) . .0 ( ) ( )	( ) ( )	0 0 ( ) 0 0 / ( ) 0 / ( )
	1 ( 0 ) 1		0 1 0 / ( ) 0 . / ( )

---

	0- %	1. %	/
	- 0%	1. 0. %	/

# 中山市地图

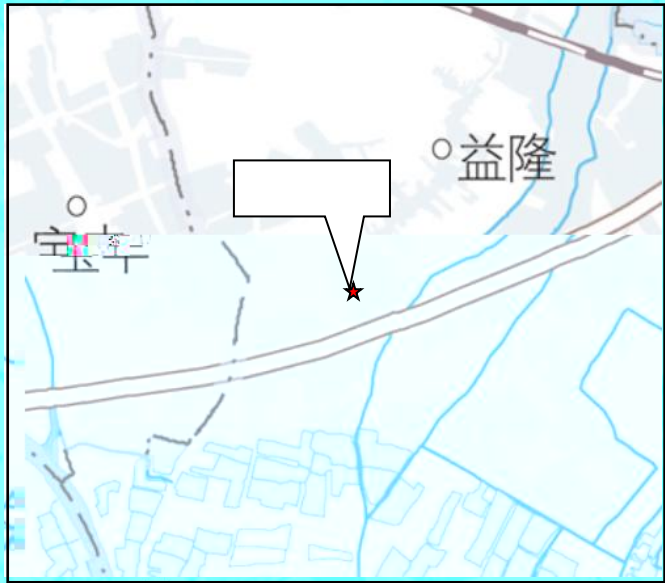
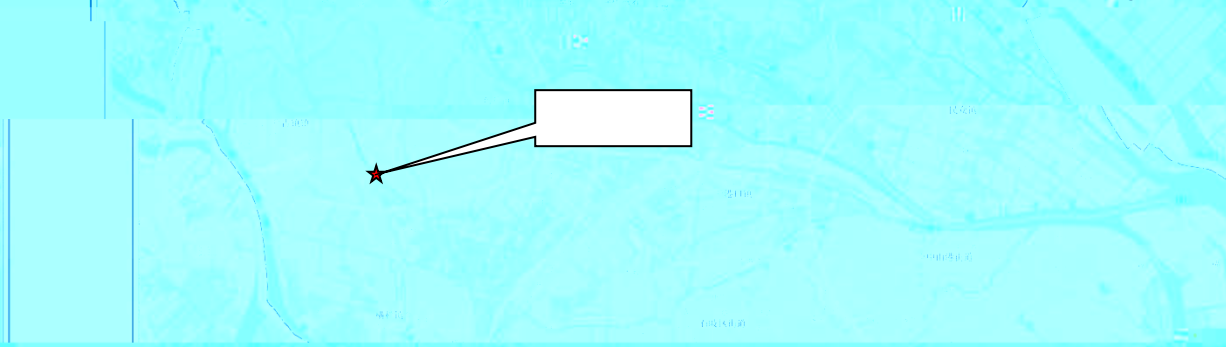
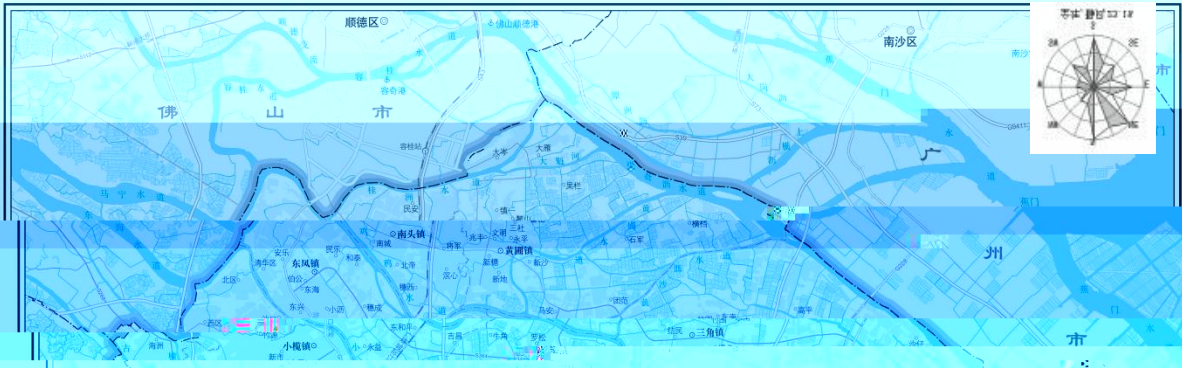

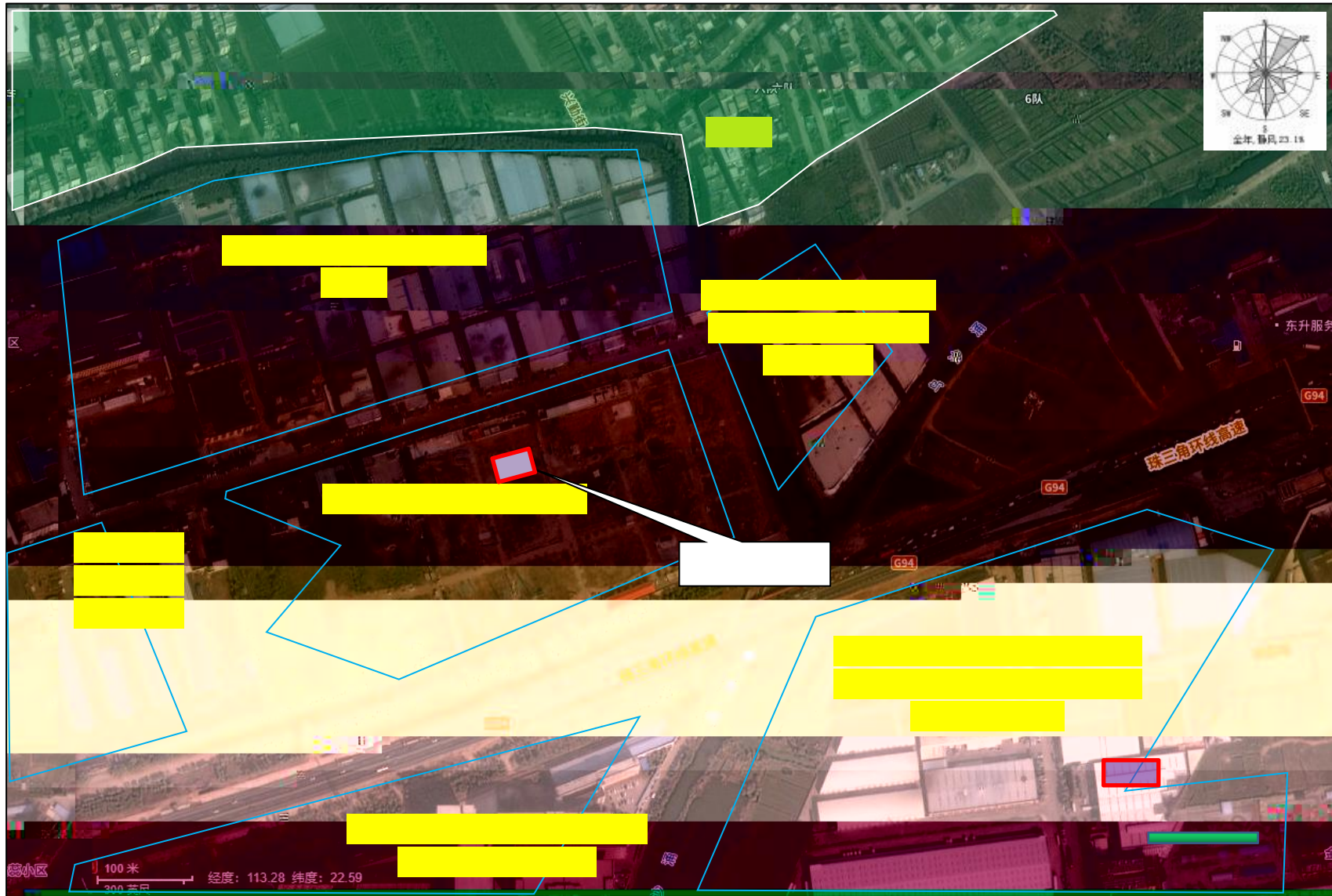

1		1	00	00	1 00	1	
		1	00	00	1 00	1	/
			00	00	1 00	1	/
	1		00	00	1 00	1	
			00	00	1 00	1	
		1	00	00	1 00	1	/
			00	00	1 00	1	/
1			00	00	1 00	1	
			00	00	1 00	1	/
			00	00	1 00	1	
		1	00	00	1 00		

I

		1	00	00	1 00	1		/
			00	00	1 00	1		/
		1	00	00	1 00	1		
		1	00	00	1 00	1		/
10			00	00	1 00	1		/
11		1	1000	00	1 00	1	100-110	
1		1	00	00	1 00	1		/
1			00	00	1 00	1		
1			000	1000	1 00	1	100-110	
1			000	00	1 00	1		/
1			000	00	1 00	1		/
1			000	1000	1 00	1		
1			000	00	1 00	1		/
1			000	00	1 00	1		/
	0	1	000	1000	1 00	1	1 -	+
1			000	1000	1 00	1	1 -	+
			000	1000	1 00	1	/	/
		1	000	1000	1 00	1		/
			000	00	1 00	1		/
			000	00	1 00	1		/
		1	000	1000	1 00	1		
			000	1000	1 00	1	/	/
			000	1000	1 00	1		
		1	000	00	1 00	1		/
0			000	00	1 00	1		/
1		1	000	00	1 00	1	0- 0	
		1	000	00	1 00	1		/
			000	00	1 00	1		/

		000	00	1 00	1	0	
	1	000	00	1 00	1		/
	1	000	00	1 00	1		/
	1	000	00	1 00	1	0	
	1	000	1 00	1 00	1	0	
	1	000	00	1 00	1		/
0	1	000	00	1 00	1		/
1	1	000	00	1 00	1	0- 0	
1	1	000	00	1 00	1	0- 0	
	1	000	00	1 00	1	0- 0	
	1	000	00	1 00	1		/
	1	000	00	1 00	1		/
	1	000	00	1 00	1	0- 0	
	1	000	00	1 00	1		/
	1	000	00	1 00	1		/
	1	000	00	1 00	1	0- 0	/
0		00	00	1 00	1		
1		00	00	1 00	1		
1		00	00	1 00	1		
		00	00	1 00	1		/
		00	00	1 00	1		/
		00	00	1 00	1		
		00	00	1 00	1		
		00	00	1 00	1		/
		00	00	1 00	1		/
0		00	00	1 00	1	0- 0	
1		00	00	1 00	1	0- 0	
1		00	00	1 00	1	0- 0	
		00	00	1 00	1		/
		00	00	1 00	1		/
		00	00	1 00	1		
		00	00	1 00	1		
	10	00	00	1 00	1		

			00	00	1 00	1		/
			00	00	1 00	1		/
	0		1 00	00	1 00	1	/	/
	1		0				/	/
							/	/
			3/			1	/	/
			000				/	/
							/	/
						1	/	/
						1	/	/

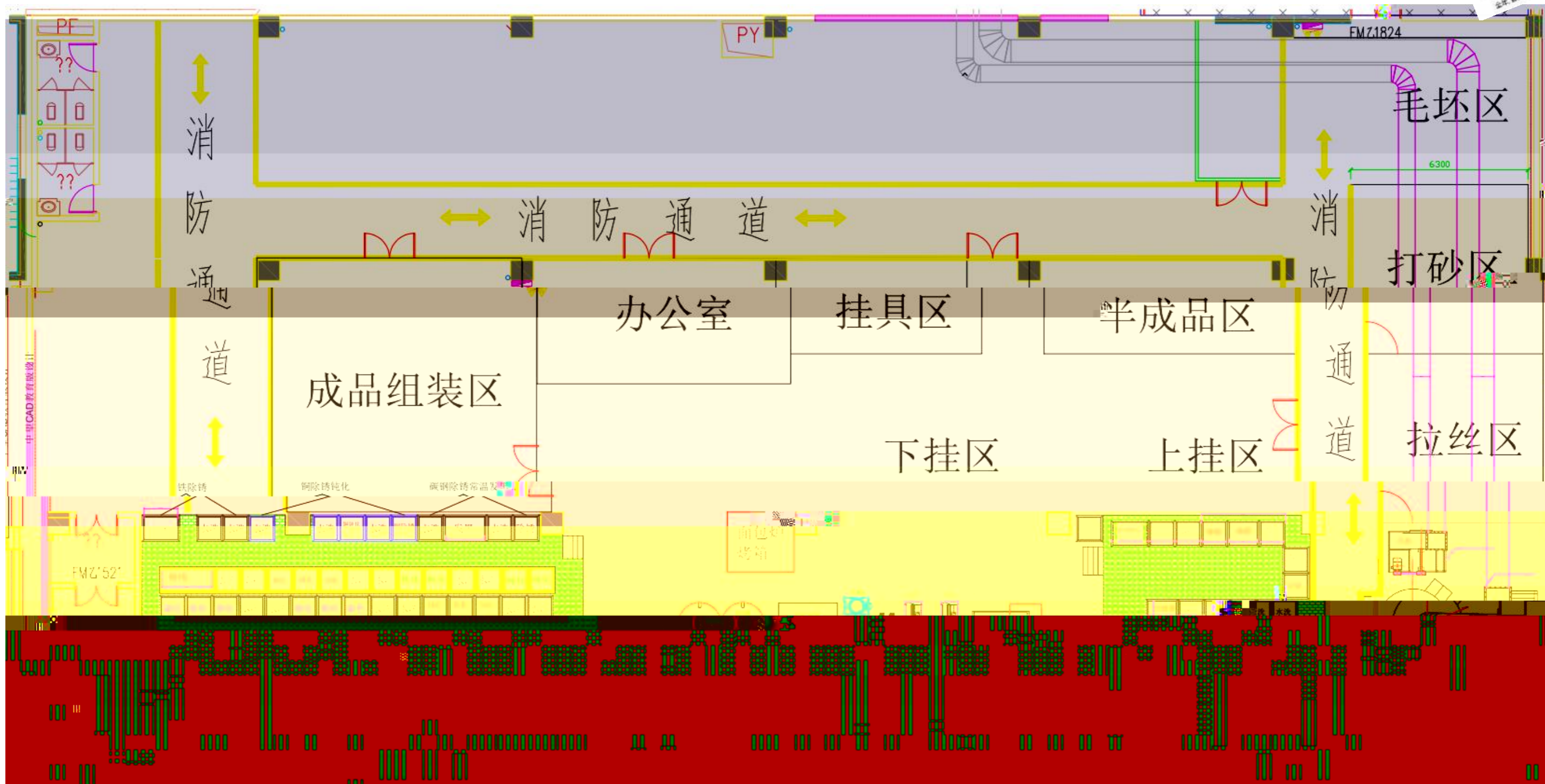

1 0  
1  
/ 1 1. - 0 1  
1 0 /  
1 00 / 0  
/ 1 0 0 / 0%  
0. /  
1  
/ 1  
% 0. /  
0. / 0.00 /  
-1 -1 -1  
||

					/			/		
					/	/				/
1		1 00	00	1 00			0			0
1	1	00	00	1 00	1	0	0			0
	1	00	00	1 00			0	.		0
	1	00	00	1 00			0			0
	1	00	00	1 00			0			0
	1	00	00	1 00	1	0				0
	1	00	00	1 00						0
							.	.		

%

0. /

. /

. /

0. /

10

					/			/		
					/	/				/
1		00	00	1 00			0			0
1		00	00	1 00	1	0		.		0
		00	00	1 00			0			0
		00	00	1 00						0
		00	00	1 00			.			0
							.	265.3		504

1 0

%

10

0. /

. /

. /

									/			/
1		00	00	1 00					0	0	0	0
		00	00	1 00				1 0	0	.	0	
		1 00	00	1 00					0	0	0	0
		00	00	1 00					.	0	0	
	1	00	00	1 00					0	0	0	0
		00	00	1 00					0	0	0	0
	1	00	00	1 00					0	0	0	
		00	00	1 00					.	0	0	0
									0.	.		756

%

10

. /

0. /

. /

									/				
							/	/				/	
1		1 00	00	1 00	0.				0	0		0	
1	1	00	00	1 00	0.		1 0		0	0		0	
	1	00	00	1 00	0.				0	0	.	0	
	1	00	00	1 00	0.				0	0		0	
	1	1000	00	1 00	0.				0	0		0	
	1	00	00	1 00	0.		1 0		0	0		0	
	1	00	00	1 00	0.				0	0	.	0	
	1	00	00	1 00	0.				0	0		0	
	1	00	00	1 00	0.		1 0		0	0		0	
10	1	00	00	1 00	0.					0	.	0	
11	1	1000	00	1 00	0.				0	0		0	
1	1	00	00	1 00	0.		1 0		0	0		0	
1	1	00	00	1 00	0.				0	0	.		
1	1	000	1000	1 00	0 0				0	0		0	
1	1	000	00	1 00	1.		1 0		0	0		0	
1	1	000	00	1 00	1.					0.			
1	1	000	1000	1 00	0 0				0	0		0	
1	1	000	00	1 00	1.				0	0		0	



						/			/		
						/			/		
	1	000	00	1 00	1.			0			0
	1	000	1 00	1 00	.1			0			0
	1	000	00	1 00	1.			0			0
0	1	000	00	1 00	1.			1 .			0
1	1	000	00	1 00	1.			0			0
1		000	00	1 00	1.			0			0
		000	00	1 00	1.			0			0
		000	00	1 00	1.			0			0
		000	00	1 00	1.			0			0
		000	00	1 00	1.			0			0
		000	00	1 00	1.			0			0
	1	000	00	1 00	1.			0			0
	1	000	00	1 00	1.			0			0
		000	00	1 00	1.			0.			0
0		00	00	1 00	0.			0			0
1		00	00	1 00	0.			0			0
1		00	00	1 00	0.			0			0
		00	00	1 00	0.						0.
		00	00	1 00	0.			.1			
		00	00	1 00	0.			0			0
		00	00	1 00	0.			0			0
		00	00	1 00	0.			0			0
		00	00	1 00	0.						0.

						/						
		00	00	1 00	0.			.1				
0		00	00	1 00	0.			0			0	
1		00	00	1 00	0.			0			0	
II		00	00	1 00	0.			0			0	
		00	00	1 00	0.						0.	
		00	00	1 00	0.			.1				
		00	00	1 00				0			0	
		00	00	1 00				0			0	
	10	00	00	1 00				0			0	
		00	00	1 00							0.	
		00	00	1 00				.1				
0		1 00	00	1 00				0				
1								1910	IIIIII	0.	.	

|

|

1 10 /

| | | |

530.5 /

|

10

						/	/	
1		1 00	00	1 00	0.	.1	.1	1
1	1	00	00	1 00	0.	.1	.1	1
	1	00	00	1 00	0.	.1	.1	1
		/	/	/	/	.	1 . 1	
0%								

						/	/	
1		00	00	1 00	0.	.0	.0	1
1		00	00	1 00	0.	.1	.1	1
		/	/	/	/	.	.	
0%								

						/	/	
1		00	00	1 00	0.	.0	.0	1
1		1 00	00	1 00	1.1	.1	.1	1
	1	00	00	1 00	0.	.1	.1	1
		00	00	1 00	0.	.1	.1	1
		/	/	/	/	1 . 1	1 . 1	



						/	/			/	
	1000	1000	1 00	0 0	.	10. 1	1 /	1	0		
10	1000	1000	1 00	0 0	.	1	1 /	1	.1		
11	1000	1000	1 00	0 0	.	1	1 /	1	.1		
1	1000	00	1 00	1.	.	10. 1	1 /	1	. 1		
1	1000	00	1 00	1.	.	.	1 /	1	1.		
1	1000	1 00	1 00	.1 0	1 .10	1 . 1	1 /	1	.1		
1	1000	00	1 00	1.	.	10. 1	1 /	1	. 1		
1	1000	00	1 00	1.	.	10. 1	1 /	1	.		
1	1000	00	1 00	1.	.	10. 1	1 /	1	.		
1	1000	00	1 00	1.	.	10. 1	1 /	2	. 1		
1	00	00	1 00	0.	.	.	1 /	1	0.		
0	00	00	1 00	0.	.	.	1 /	1	0.		
1	00	00	1 00	0.	.	.	1 /	1	0.		
1	00	00	1 00	0.	.	.	1 /	1	0.		
1	00	00	1 00	0.	.	.	1 /	1	0.		
1	00	00	1 00	0.	.	.	1 /	1	0.		
1	00	00	1 00	0.	.	.1	1 /	1	1.		
1	00	00	1 00	0.	.	.1	1 /	1	1.		
1	00	00	1 00	0.	.	.1	1 /	1	1.		
1	00	00	1 00	0.	.	.1	1 /	1	1.		
1	00	00	1 00	0.	.	.1	1 /	1	1.		
0	10	00	1 00	0.	.	.1	1 /	1	1.		
1					1 .	. 1			. 1		
		0%						%			
		%									

---

	.	0	2.664	0	0	0	0	0	0	0	0	0	6.656
	2.664	0	1.332	0	0	0	0	0	0	0	0	0	3.996
	2.664	2.33	2.664	0	0	0	0	0	0	0	0	0	7.658
	0	0	0	5.988	2.996	5.492	5.824	4.16	8.32	3.328	8.78	21.304	66.192
	9.32	2.33	6.66	5.988	2.996	5.492	5.824	4.16	8.32	3.328	8.78	21.304	84.502

	/	/	/	/	/	/	/
	.	265.3	0.00	0.	0.	.	0
	.	265.3	0	.	0.	.	0
	0.	265.3	0	.	.	.	
	1 10	2122.2	0.	.	.	.	.
	2971.2	2918.1	530.5	6684.9	6419.8	321.4	6098.4

10 .1%

. %

0%

/ 1

0 0 /

0%

0. /

	/		/
	0.	.	.
	0.	.	. 1
	.	.	.
	.	.1	.
	.	.	.

		m³							m³						m³
		8.185	5.46	5.46	0	1.10		11.	0.1	0.609	0.0	0	1.1	.0	1.
		8.256	4.128	8.256	0	0.		5	0.1	0.206	0.1	0	1.0	1.0	1.0
		0	0	7.222	0	.		.	0	0	1.	0.0	1.	.0	.01
									0	0	0.0	0.000	0.0	1.10	
		0	0	0	10.18	10.1		20	0	0	0	2.036	0	1	8.144
		0	0	0	9.287	.			0	0	0	0.	0.	0.	.
								1.	0	0	0	0.139	0.1	0.0	
		0	0	0	17.025	1.0		8.4	0	0	0	1.	1.	1	1.0
							68%	1.6	0	0	0	0.1	0.1	0.	
		0	0	0	1.0	1.0		30.7	0	0	0	.	.	10.1	0
								69.3	0	0	0	1.1	1.1	1.0	
		0	0	0	1.	1.		11.2	0	0	0	1.1	1.1	.1	1.0
		0	0	0	.	.		7.5	0	0	0	1.	1.	.	.



m'

C

b

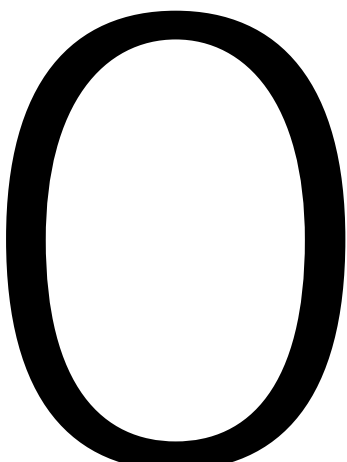

0	0	0	5.988	.
0	0	0	2.996	
0	0	0	5.492	.
0	0	0	5.824	.
0	0	0	4.160	.1 0
0	0	0	8.32	.    0
0	0	0	8.78	. 0
0	0	0	21.304	1. 0
0	0	0	3.328	.

	10			
#	11			0
#	1			1 0
	1			
#	1			100
#	1			0
	1			
#	1			100
	1		/	
#	1			1
				01
				01

1		
1	/	.
		0
	/	10
	/	0
	/	0.
	/	0.1
	/	0
10	1 /	0
11	1 / /	0
1	1 / /	0
1	( / )	0
1	/	10
1	/	1
1	/	1

1	/	0.
1	/	0.0
1	/	000
1		00

0%

1		00		

GB/T19923- 2005 "

"

3. 2- 26

40%

3. 2- 25

45. 5%



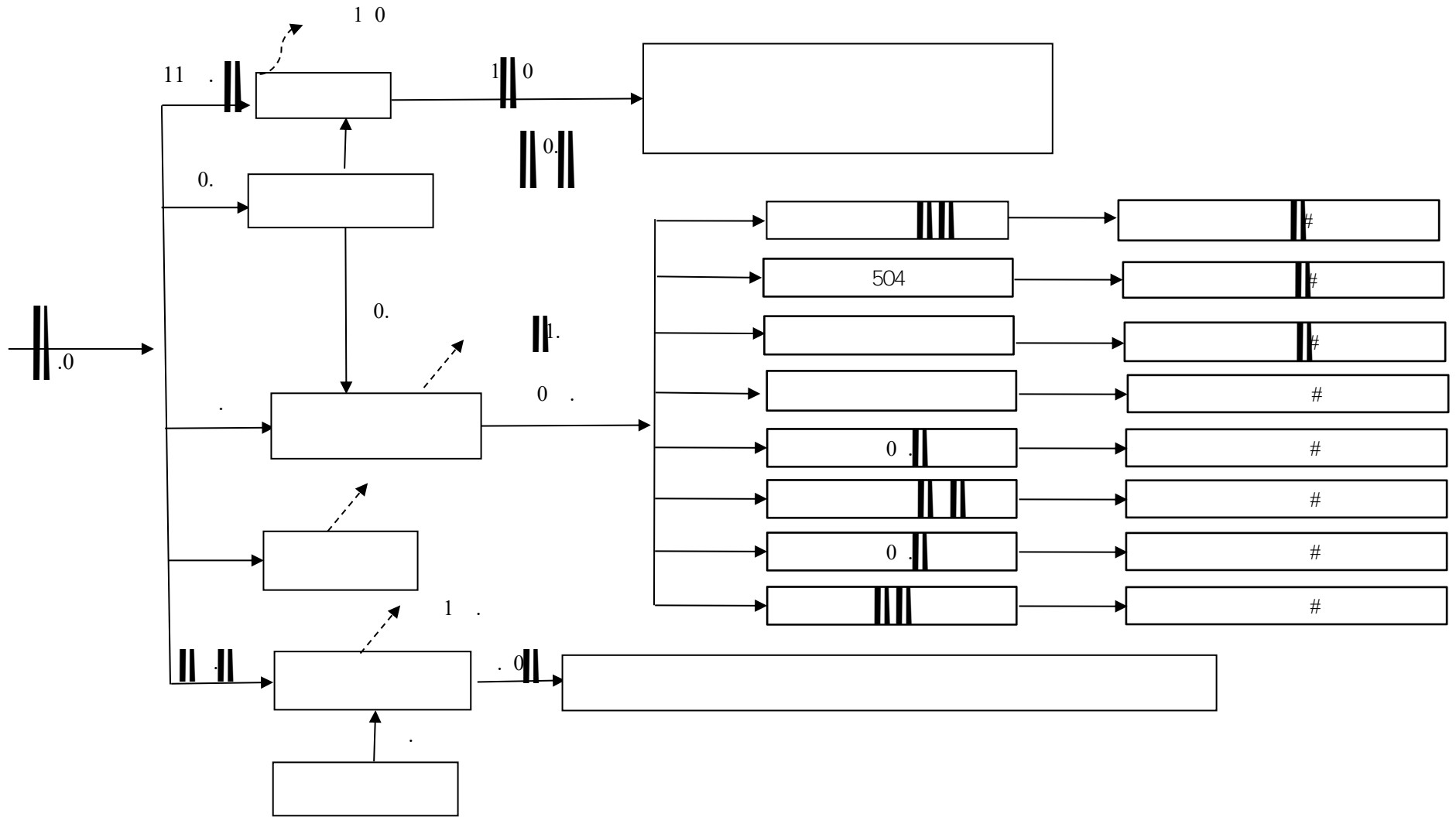

SR

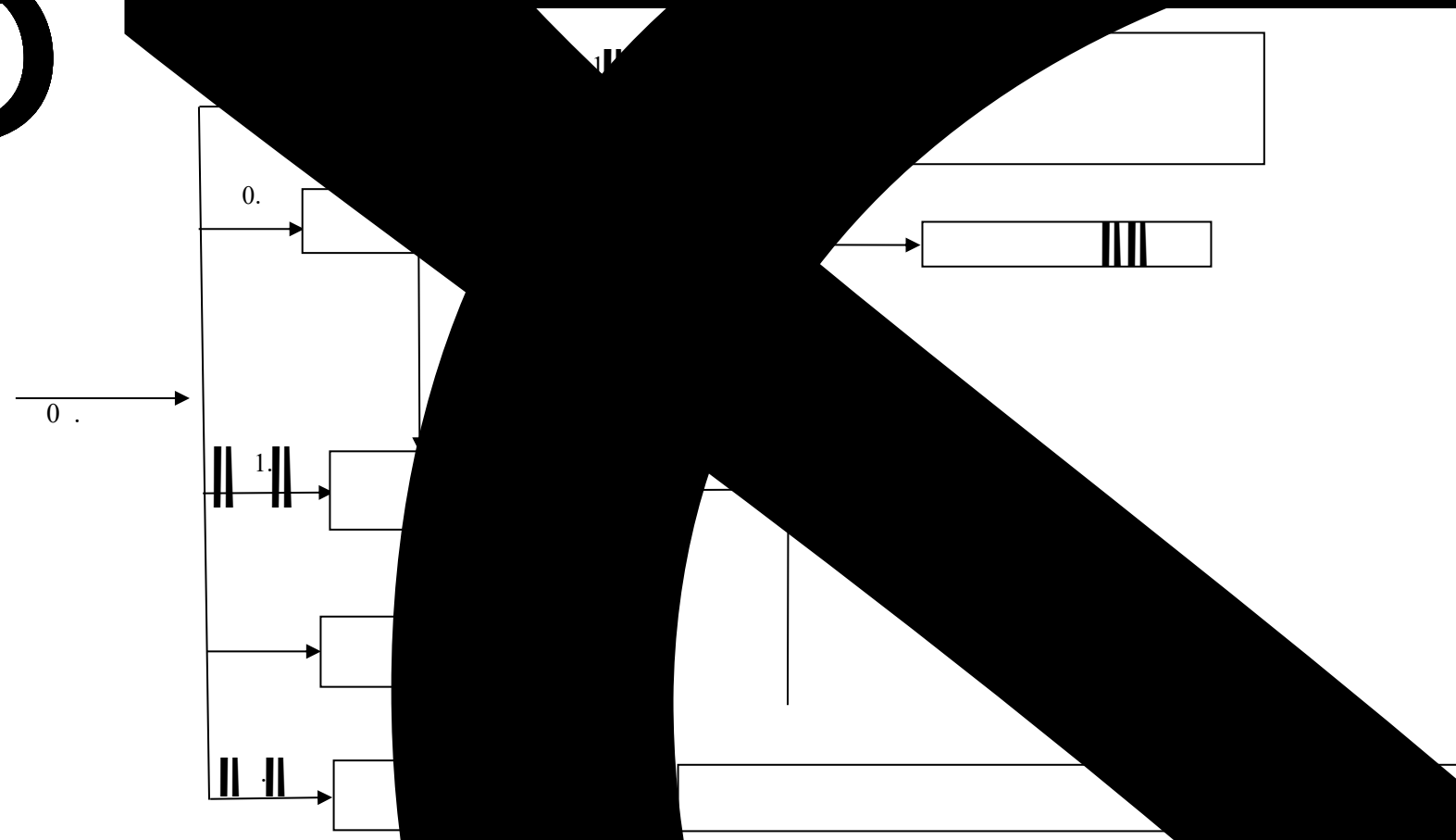

1 0

0

10

1 00

1 00

1		



0. 0

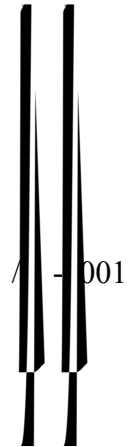

/1 - 01  
/ - 001



1 /

/



/

10 /

/

0

1 /

0

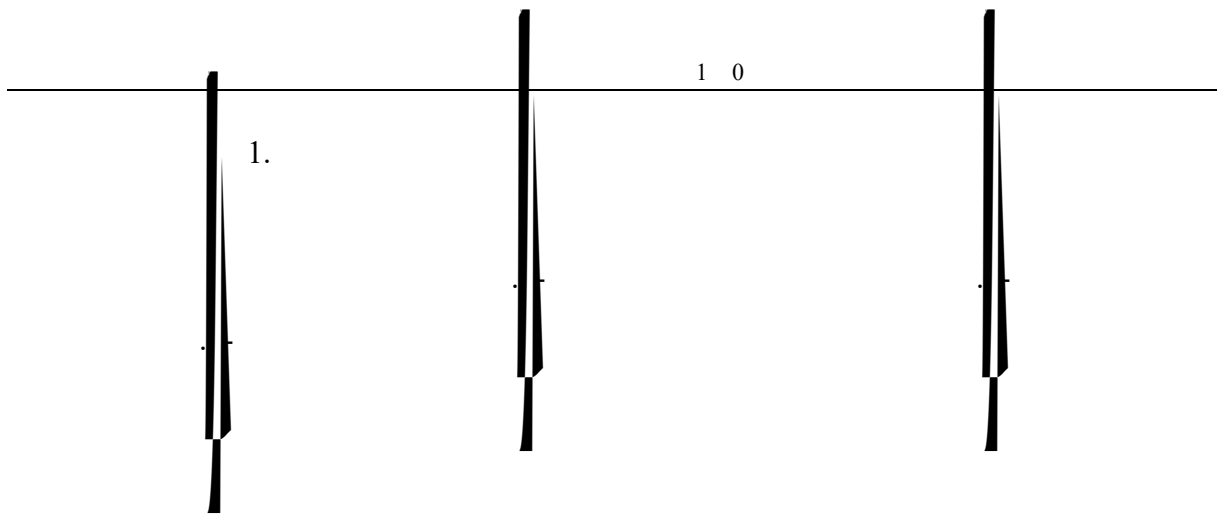





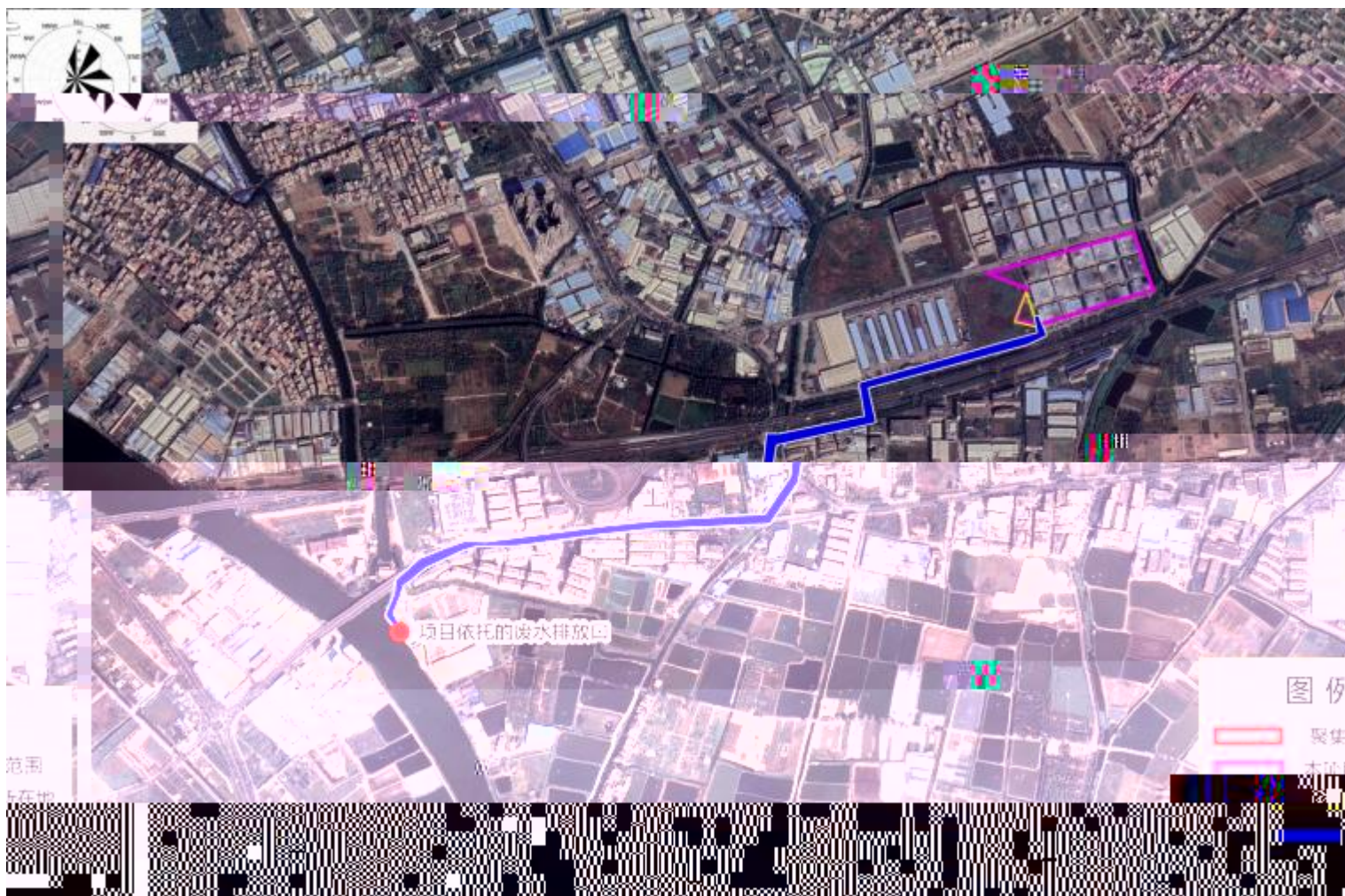

0

1.

m

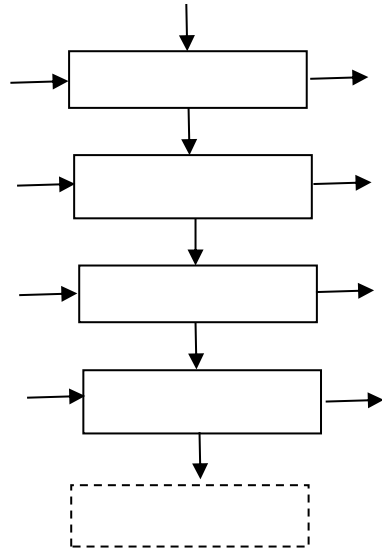

4.1-2

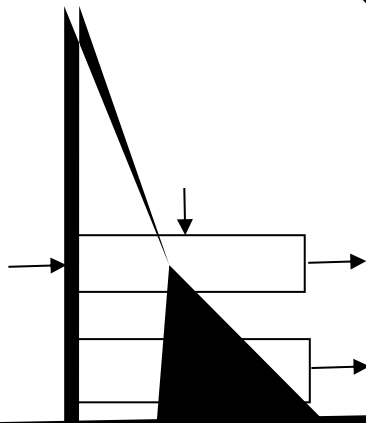

4. 1-3

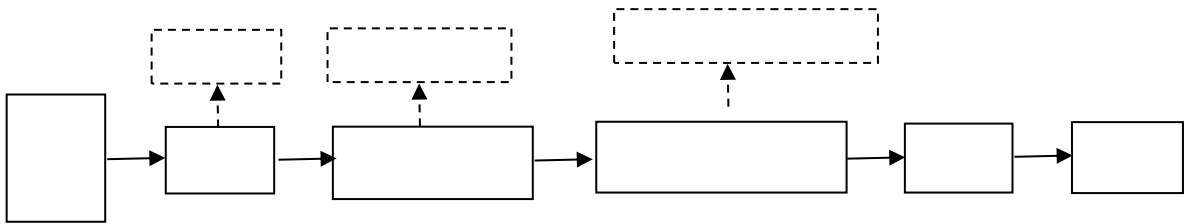

1

1 0



1 0

0%

1 0



100-110

%

%

0.01 0.0

0.001 0.00 0

0- 0

0- 0

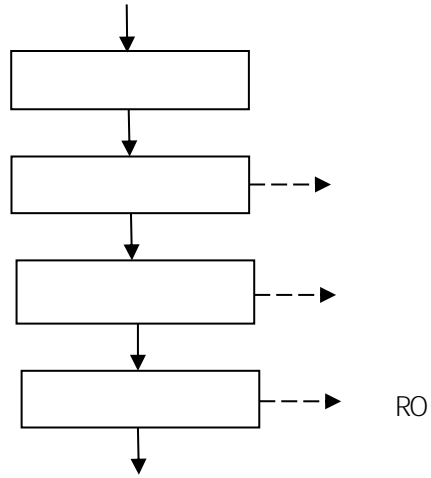

4. 1-7



		-



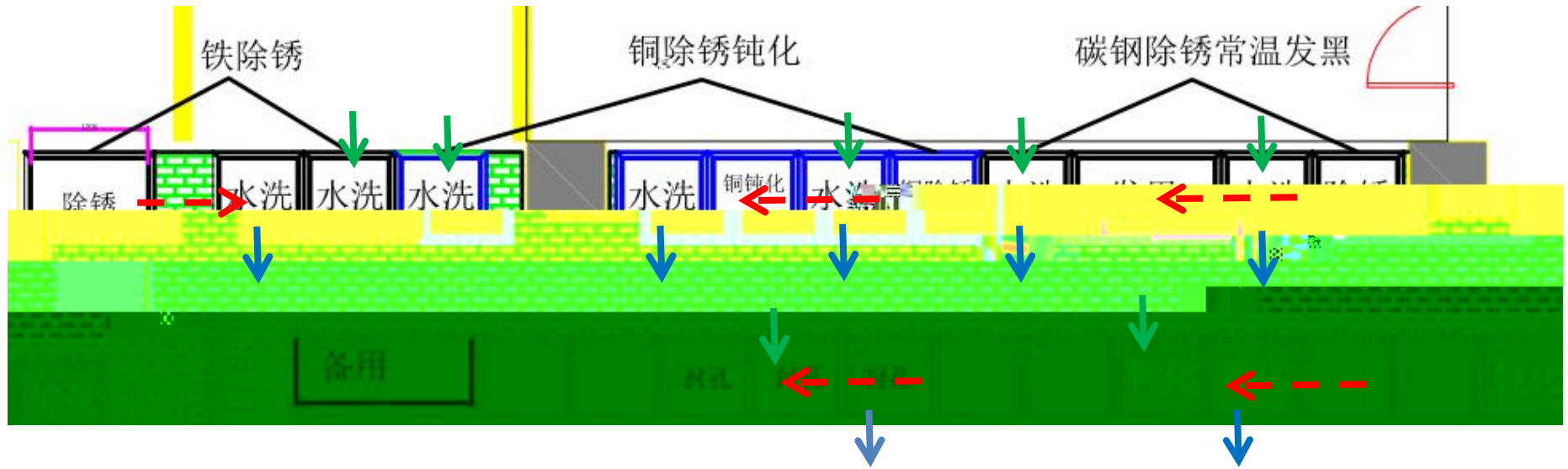

4.1-8

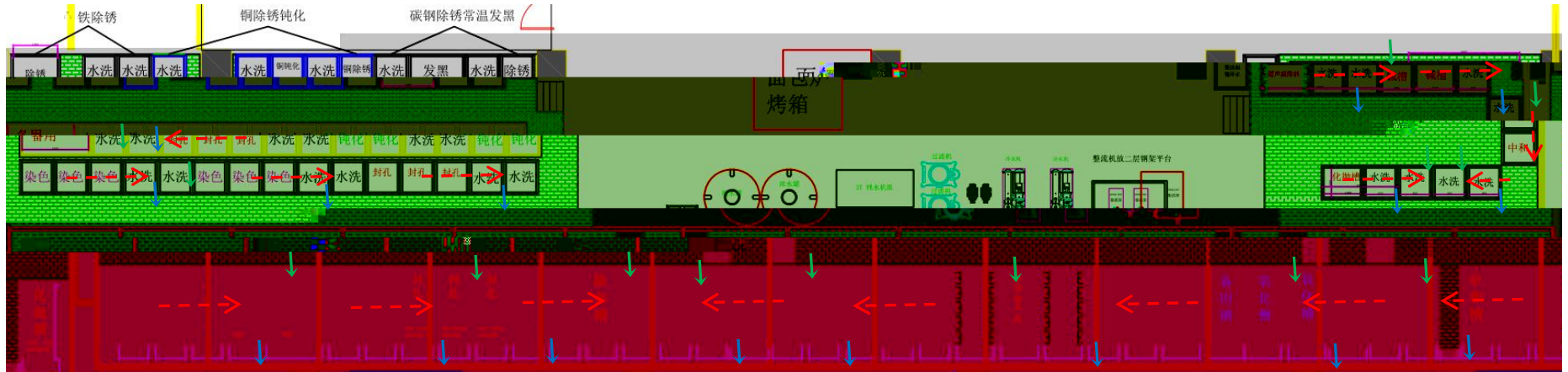

4.1-9

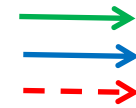

%	0.	0.		0.1	1%
				0.	%
				0.0	1 %
				0.0	%
	0.	0.		0.	100%

%	1.0	0.		1.	%
				.0	%
				1 .	%
				0	%
	1.0	0.		0.10	100%

%	1.0	1 .		10.	0%
					%
				0.	%
	1.0	1 .		1 .	100%

	0.	0.    %	0.1	0.0	%
				0.00	. %
				0.10	. %
				0.00	%
	0.	/	0.1	0.1	100%

	0. 1		0.1	0%
			0.1	%
			0.0 1	10%
			0.0 0	%
	0. 1		0. 1	100%

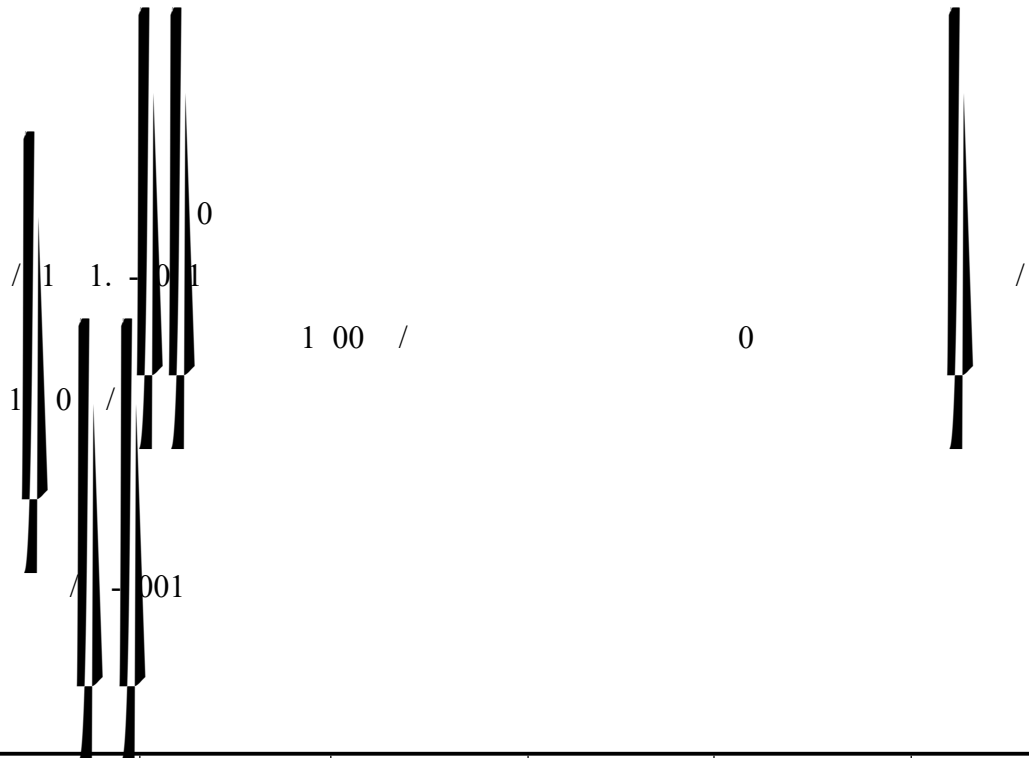

/		/	/	/	/
01		0	0. 1	0	0.
		1 0	0.1	1 0	0.1
		1 0	0.1	1 0	0.1 1
	-		0.0		0.0

0 . /

/

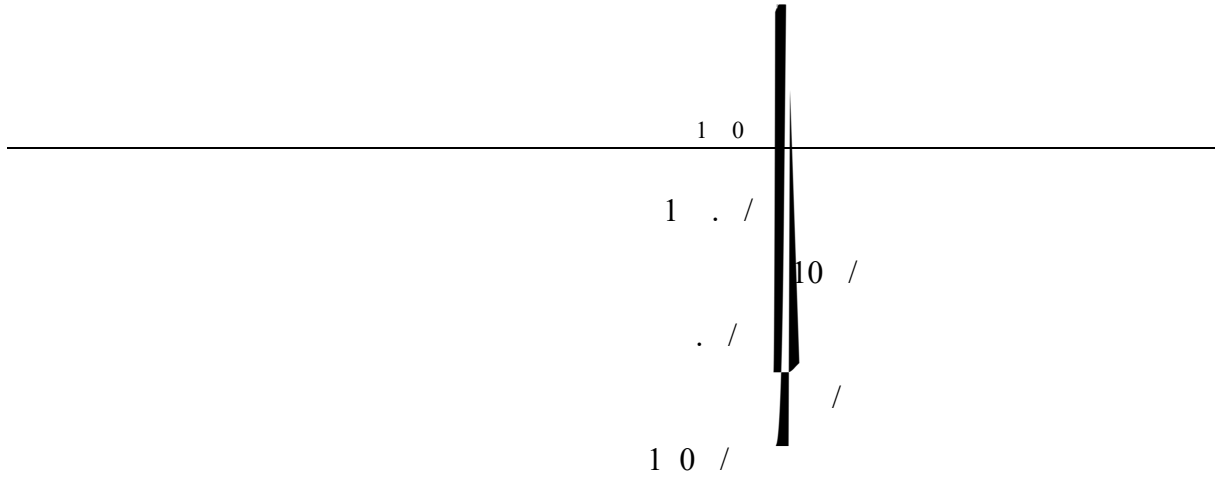

	1 0 /	0	1	/
( ) 1 1. / 0 /	. 1 / /	1. 1 . / /	10. / /	

(

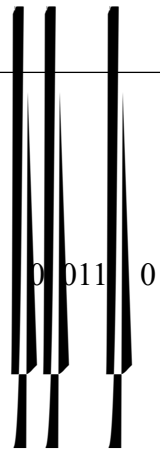

.0

.0

.

.

1. 

1. 

.

10.



/1 -01

-001

			/													
1 #			100	10000	0	1 0	00	0	--	000	--	000	--	0	--	10
#			0	11		11	1	0	--	1	10	1 1	--		--	10
			0	000	000	0	00	--	--	000	--	10	00	--	--	

		/														
#		100	000	00	1 0	1 0	--	--	000	00	0	00	--	--		
		0														
#		100	1000	0	0	0	--	0	00	--	10	--	--	--		
		00														
#		1 0	1000	0	0	0	--	--	00	10	0	--	--	--		
		100														
#		100	1000	0	1 0	1 0	00	--	00	--	10	--	--	--	10	
		0	#													
#		0	#			8#					2#					
		1	0	--	--	--	--	--	00	--	--	--	--	--	1 0	
		01														

-01

		100 / *	100 /	0 / 00 / 00 / 100 /
		10. / *	10% 1 %	1 / 1. % 10% 1 % 10. /

		0.			0	. . .	1 0	0.0
		0.			0	. . .	1 0	0.0 0
		0.			0	. . .	1 0	0.0 0
1#					1 0	. . .	1 0	0. 0

			100-110	0	.	1 0	0. 0
			1 -	00	.	1 0	0.
#	1.			1 0	.	1 0	0.11
	1.		100-110	0	.	1 0	0.11
	.		1 -	00	.	1 0	0.
1#				1	10.	1 0	0.0
#	1.			1	10.	1 0	0.0

+

	(0)	1	0%	
1#	1 0.	1#		
1#	0 .	1	/	0
1#	0 .	1	0000	0

1 0

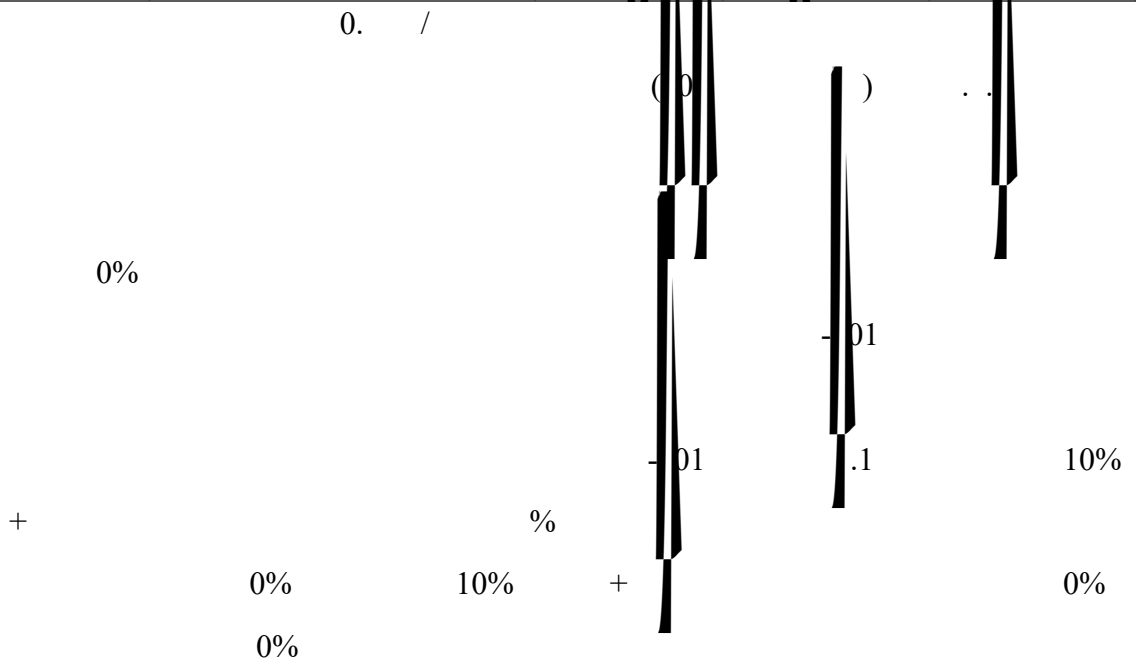
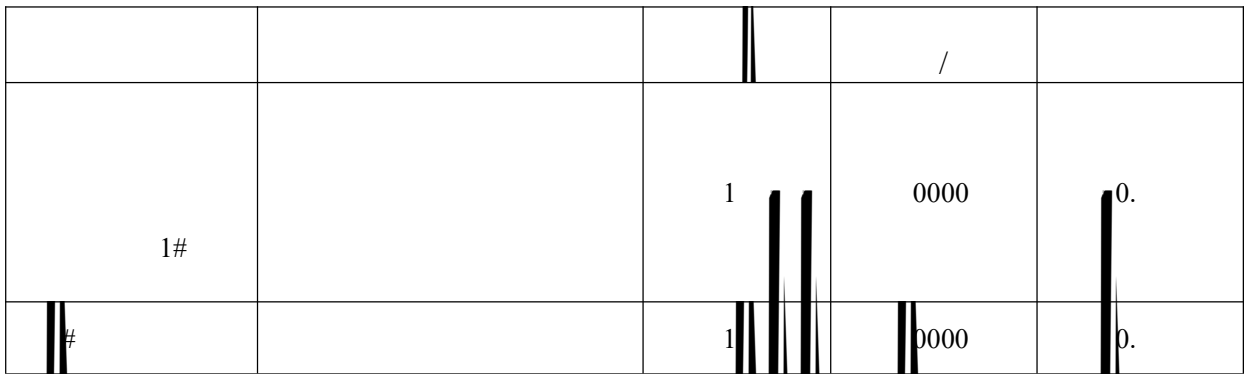
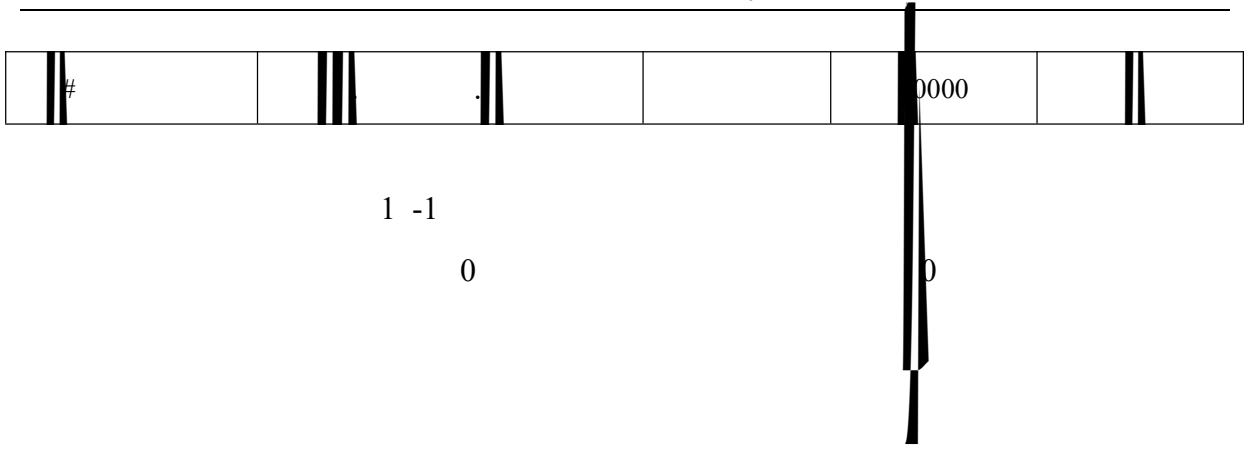

1

1



/	0.1	0.0
/	0.0	0.01
/	1.1	0.
/		

1 00-00

100 .

1 /

1 /

0

100 .

( 0 )

%

1 % % 1. /

0%

0.10 /

000

%

	/	1
	/	0.10
	/	0.0
		000

/ -001

/ -001

0%

00.

0

00.

0. /

1 /

1 0

( 0 ) . .

0%

%

0. 0% % 0. /

0%

0.0 /

000

	/	0.
	/	0.0
	/	0.01
		000

/ - 001

/ - 001

+

1

/ - 001

		1	
			1
			1
			1
1#			1
1#			1
		0	1
			1
		0	1
			1
		0	1
		0	1

100

0 /

0.0 /

0. /

00 /

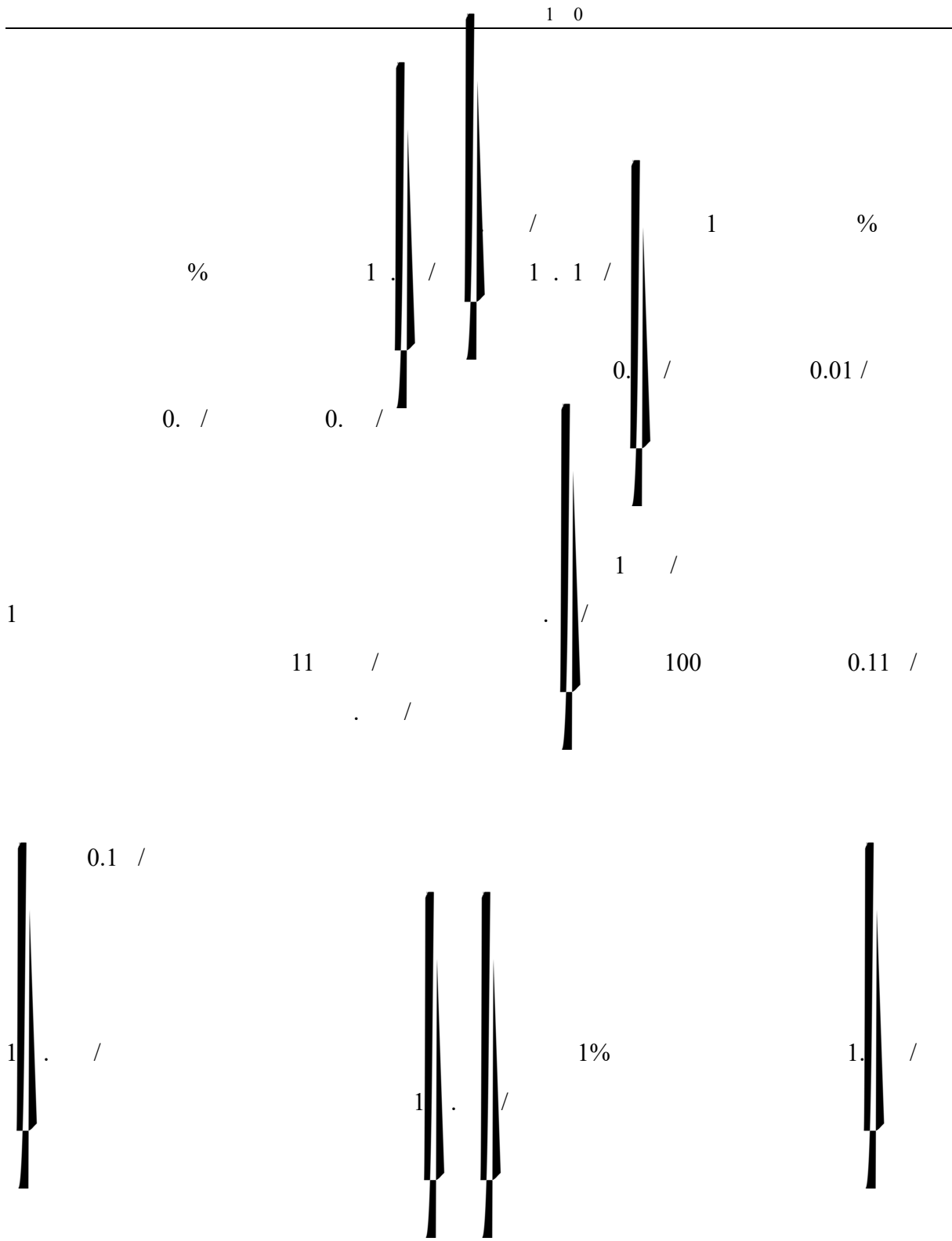

		.	/

		0.0 /	
		1 . 1 /	
		0. /	
		.	/
	/	0.1 /	
		1 . /	

1			00-0 1-	.	/				1	/	
	/										
			00-0 1-	0.1 /					1	/	
		1	-0 -1	1 . /					1	/	

1				00-0 1-				1.	
		/							
				00-0 1-		0.		0.	1
			1	-0 -1					1

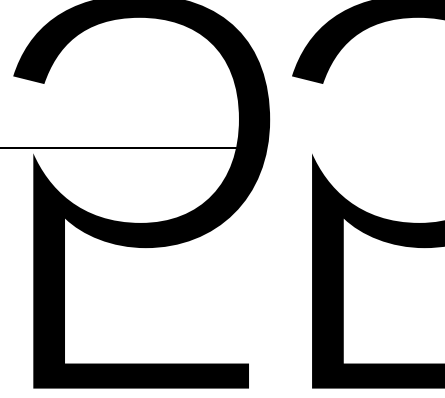

1 0 /  
P

-

/	/	/	/	/
0	00. 1	0. 038	0	0.
1 0	0.1	0. 025	1 0	0.1
1 0	0.1	0. 038	1 0	0.1 1
	0.0	0. 000		0.0

-

/	.
/	0.
/	0. 11
/	0.
/	1.
/	0.00
/	0.
/	0.0
/	0.0
/	0.0
/	0.0 0

0 . /

10.	1.	1.	/	0.1
0.	0.1	0.0	/	0.0
0.1			/	0.1
0.1			/	0.1
0.01			/	0.01

1	- 00
---	------

		0		
		0		
		0		
		.	0	.
		0.0	0	0.0
		1 . 1	0	1 . 1
		0.	0	0.
		.	0	.
	/	0.1	0	0.1
		1 . 1	0	1 . 1



1#  
0%

1

/



#

1

1.

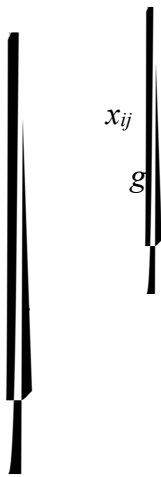
 $x_{ij}$  $i$  $j$  $g_k$  $g^1$  $g$  $g$  $g_k(x_{ij})$  $g_k$ 

100

0

$$X_{gk} = \sum_{i=1}^m (w_i \sum_{j=1}^{n_i} \omega_{ij} X_{gk}(x_{ij}))$$

 $w$  $w$  $X_{gk}$  $g^1$ 

$$Y_{gk} = \sum_{i=1}^m w_i X_{gk}$$

 $w_i$  $g$  $g$

. -1

1	0.			0.						0	100	100
				0.1						0	100	100
				0.	0%	0%		100%		100	100	100
				0.						100	100	100

		0.1	*	/	1			0	# #	:	100	100	100
		0.1		%	1	0	0	0		10 . %	100	100	100
		0.1	*	%	0.	100				100%	100	100	100
			*		0.						100	100	100
			*		0.						100	100	100
		0.0			0.						100	100	100
10					%	0.			0			100	100

11			*	0.1						100	100	100
1			*	0.1						100	100	100
1				0.1	/ 001					100	100	100
1		0.1	*	0.1						100	100	100
1				0.1						100	100	100
1			*	0.1		1		1		100	100	100

1				0.1	1 1	1 1	100	100	100
1			*	0.1			100	100	100
10%		*	/ /			/	/		

	100

通过加权平均，逐层收敛可得到评价对象在不同级别  $Y$ ，如式 (2)。

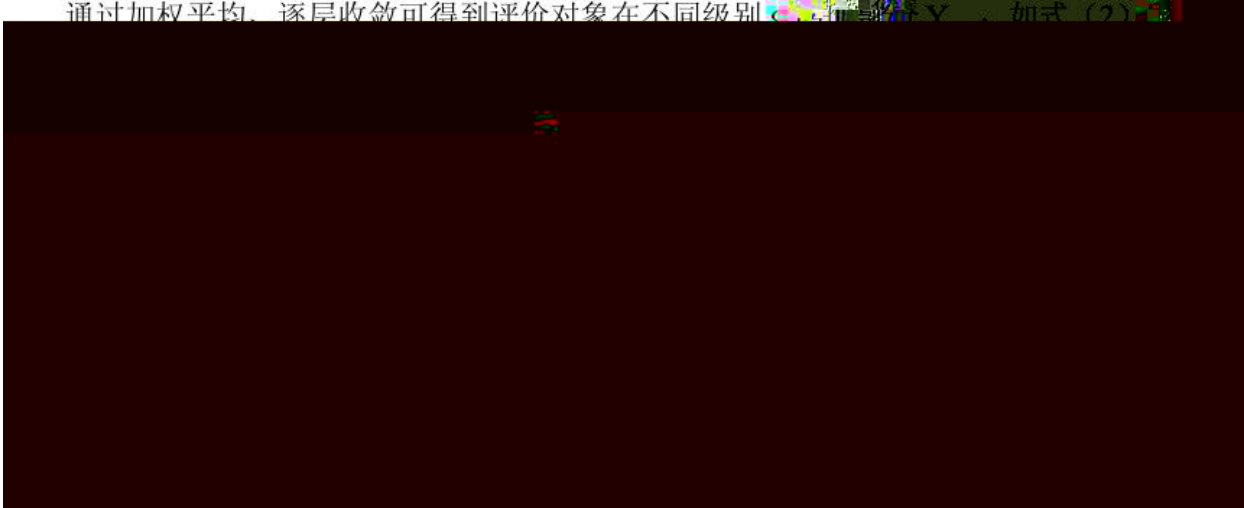

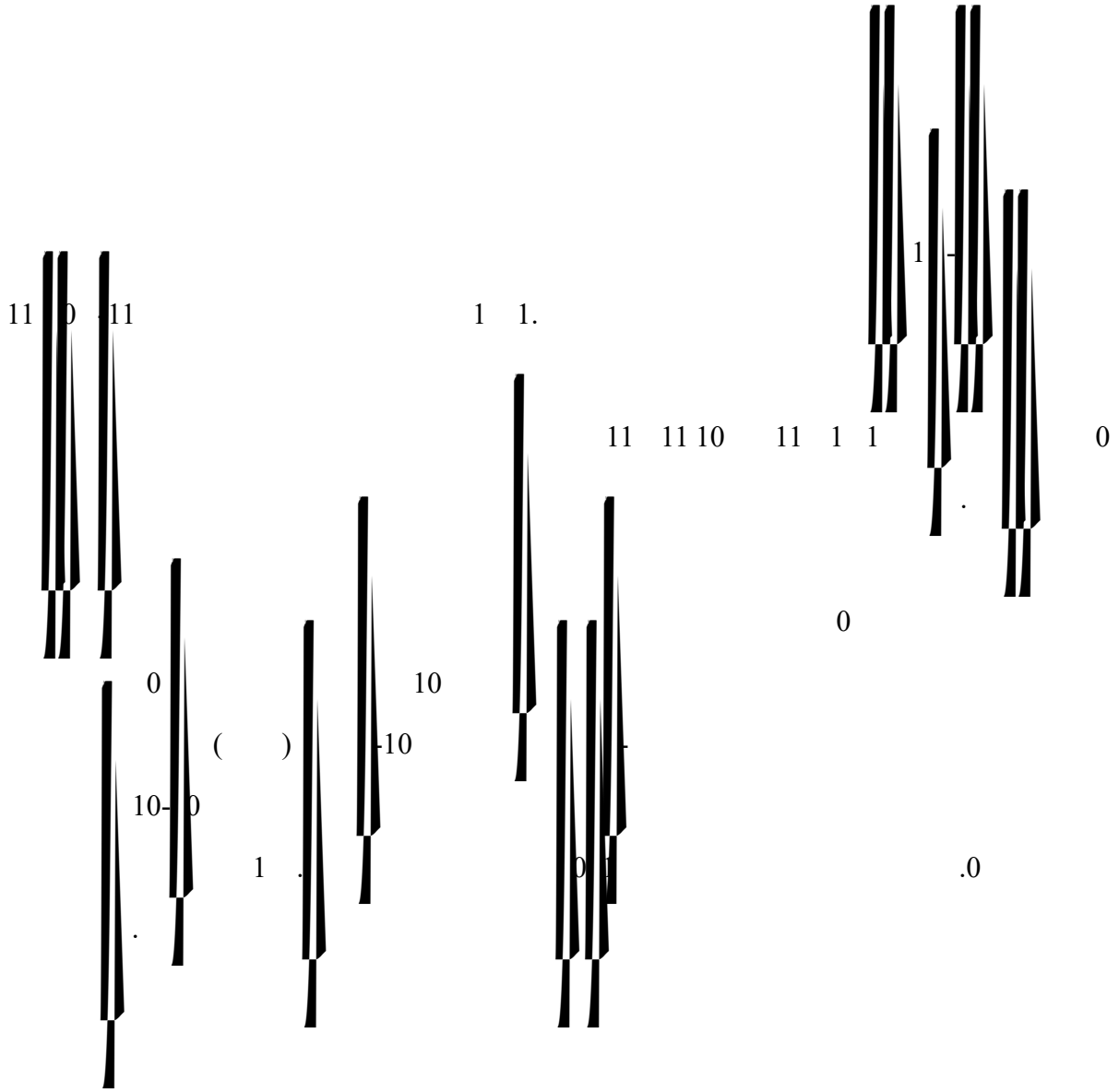

1 %- 0%

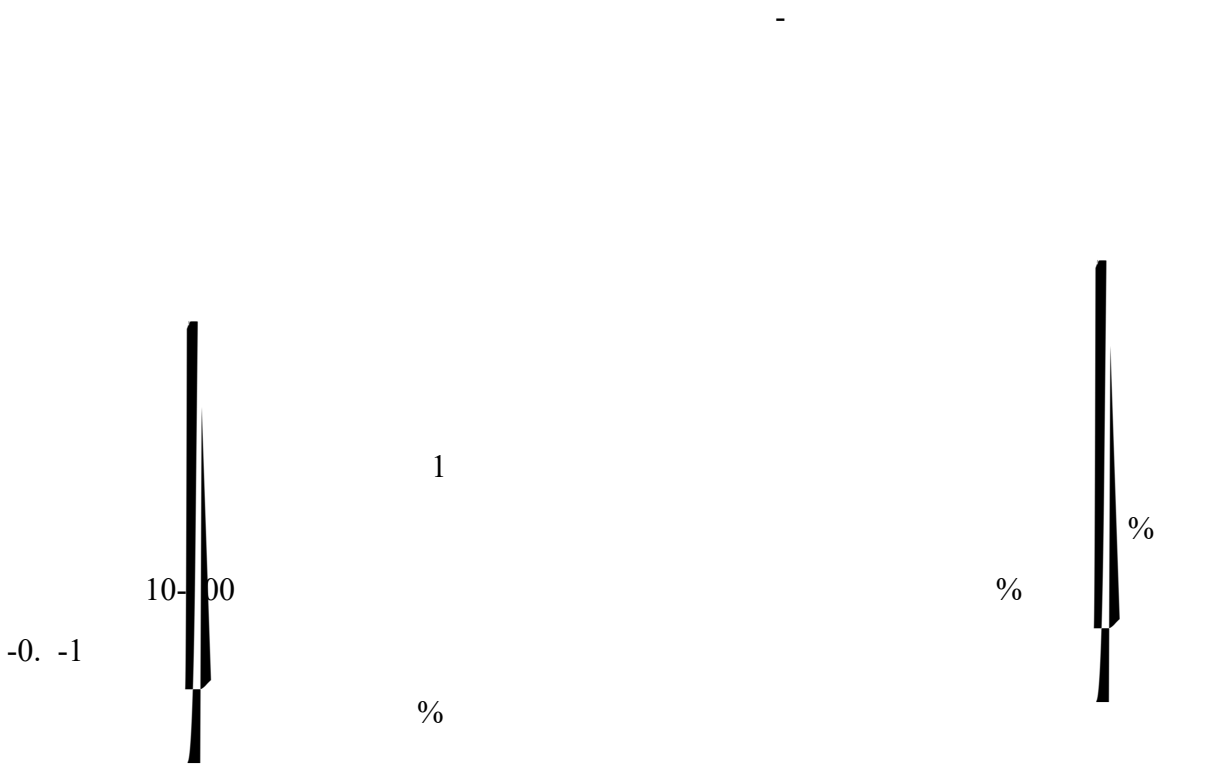
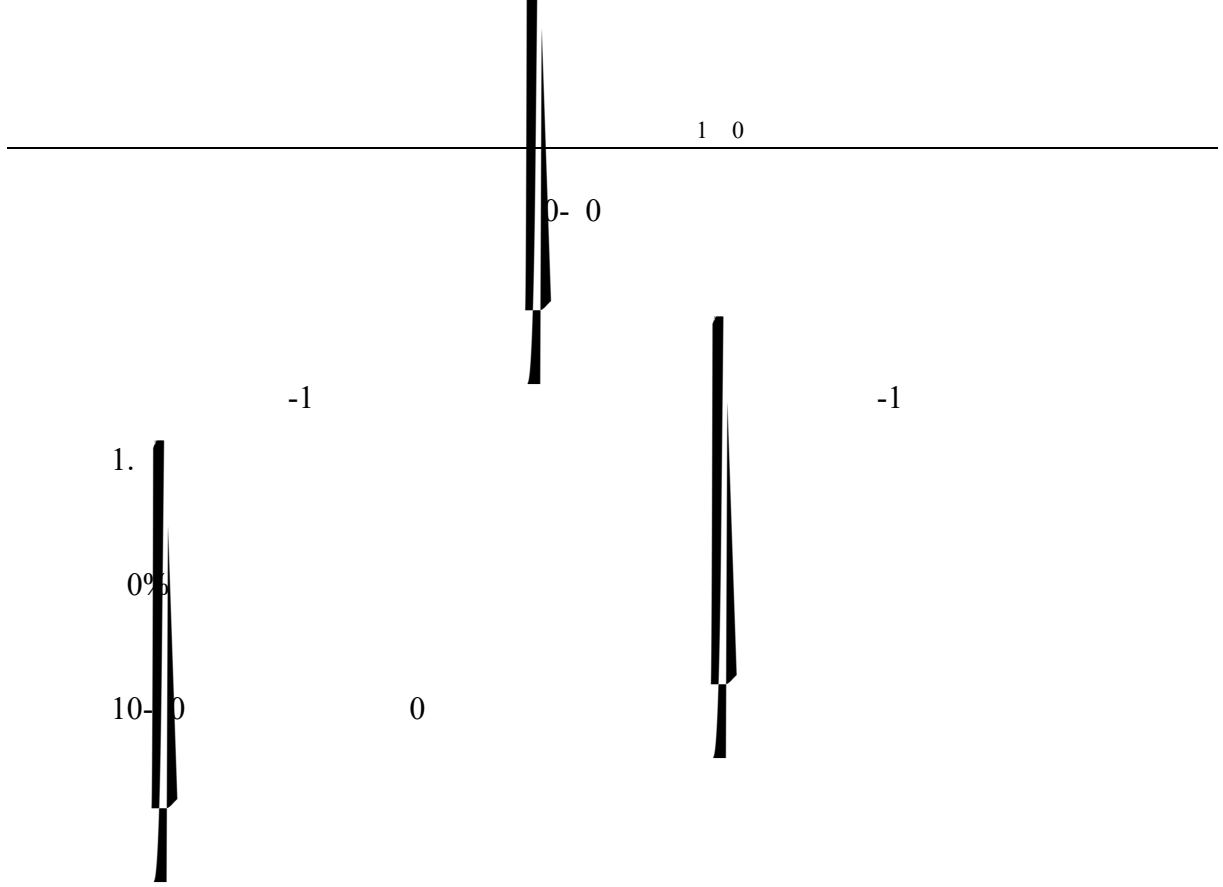



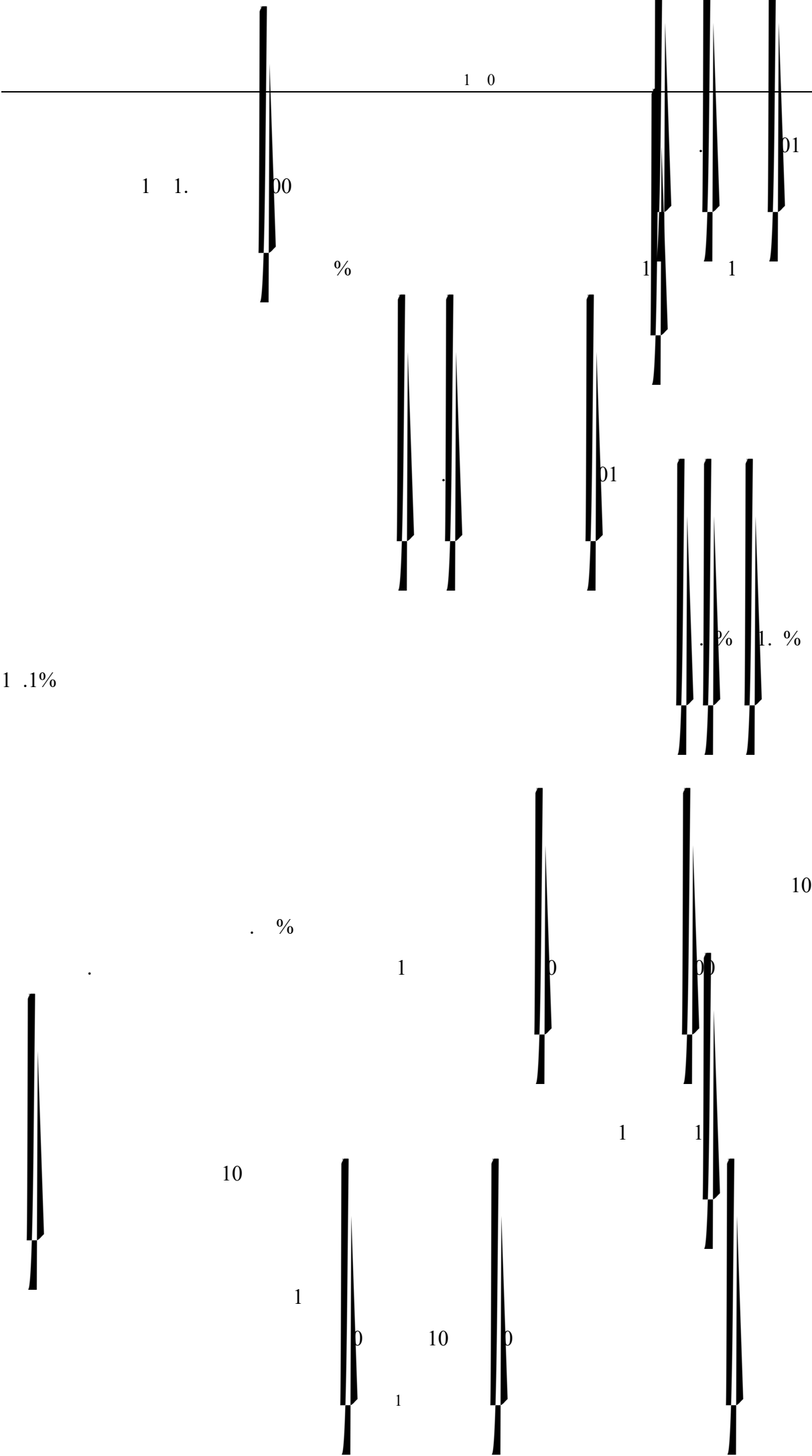

1

0%

10.

1

100

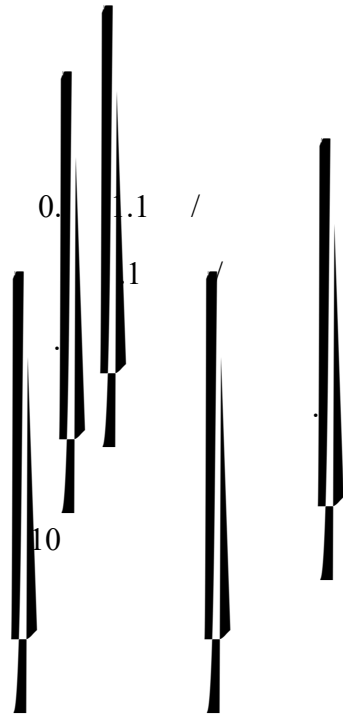

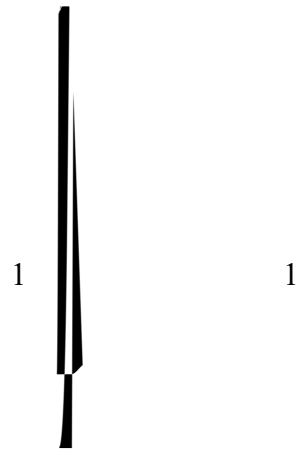



0



. %

1

10

1000



10

10

1

%

1

00

00

0

00

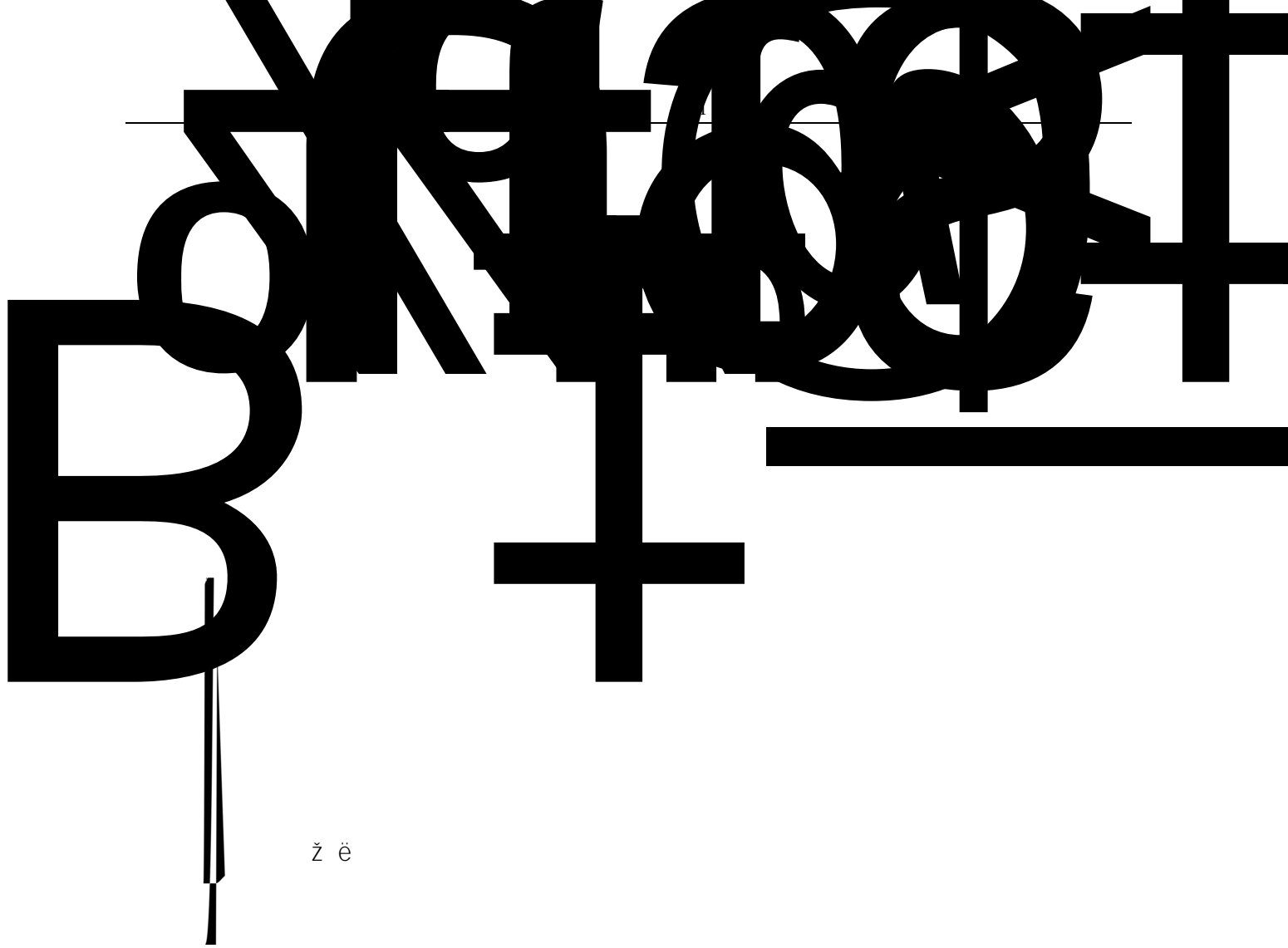

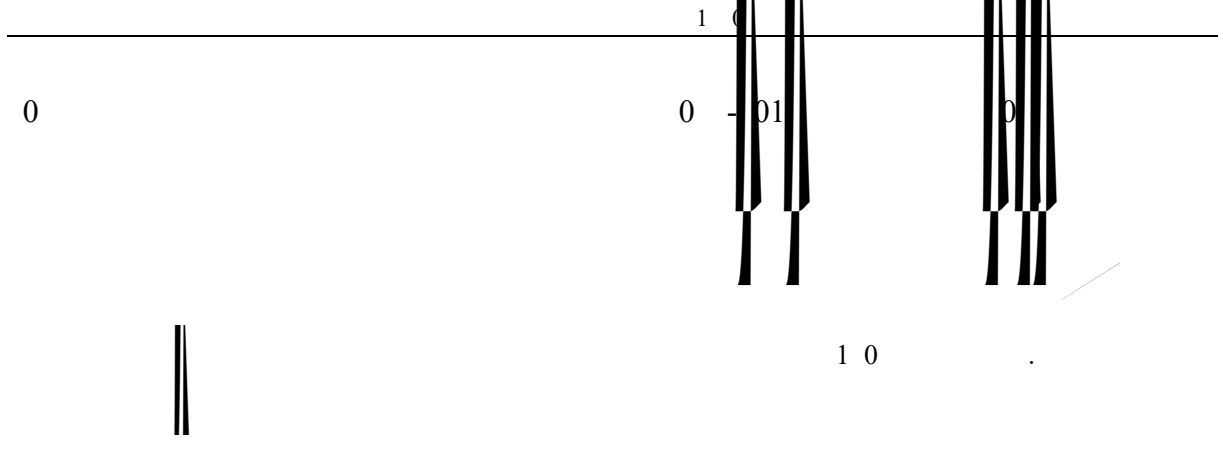

||

1 0 .

		0				
			00	000	1 .	
			10	1 0	.	
				0	11.	
				0	.	
			0	0	.0	
	10			1 0	0	
			0	0	.1	
					0	
		0	1 0	1 0	11 .	 0
			00	000	0	

	11 1			10	.1

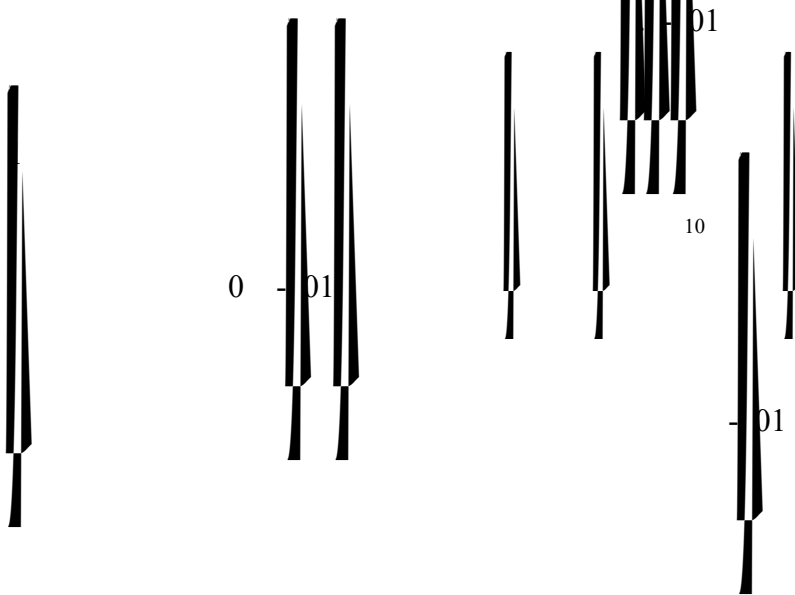

1, --

1+ -1 %  
%

+ +1 - -

		/	/	%	%	
		1	1 0	10	/	
			0	1 .	/	
			0	.	/	
		0	0		/	
10			1 0	.	/	
			0	.1	/	
				1.	/	
		1100	000	.	/	
	0	1 0	1 0	11	/	

0 10 11 1

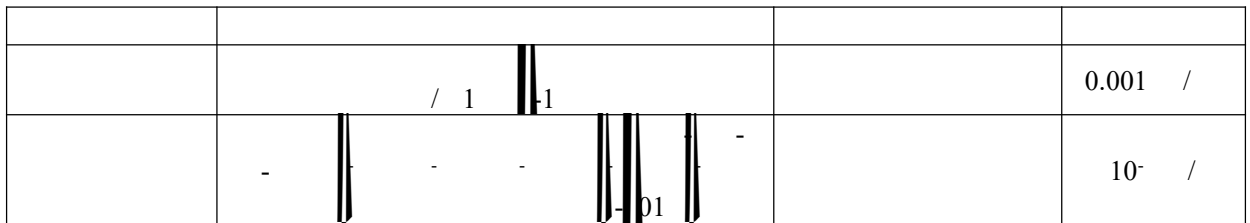
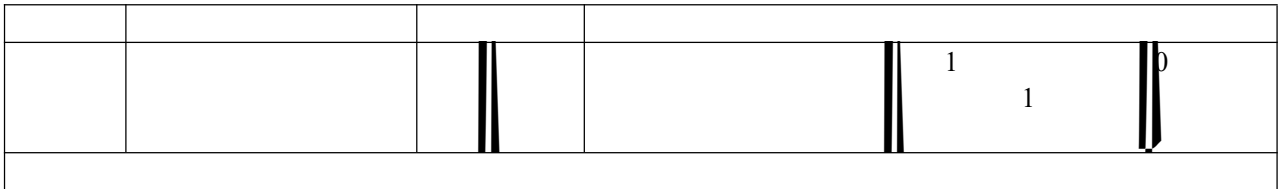
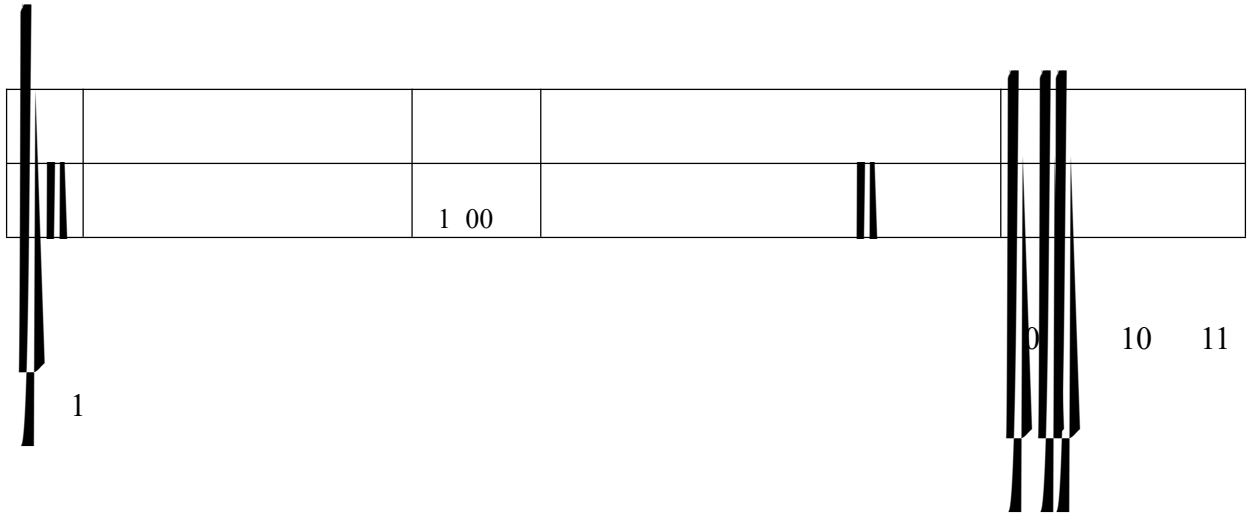

$$C_{(x,)} = \left[ \frac{1}{n} \sum_{j=1}^n C_{(j,t)} \right]$$

/

/

$$P_i = \frac{C_i}{C_{0i}}$$

%

0

1

/

/

1

0

-01

-01

			0.	0.0 0.0 1		.0%	/
	1		0.	0.0 0.0		1 .	/
			0.1	. 10 <sup>-</sup> . 10 <sup>-</sup>			/

-01

.1

0

-01

01

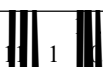

10				



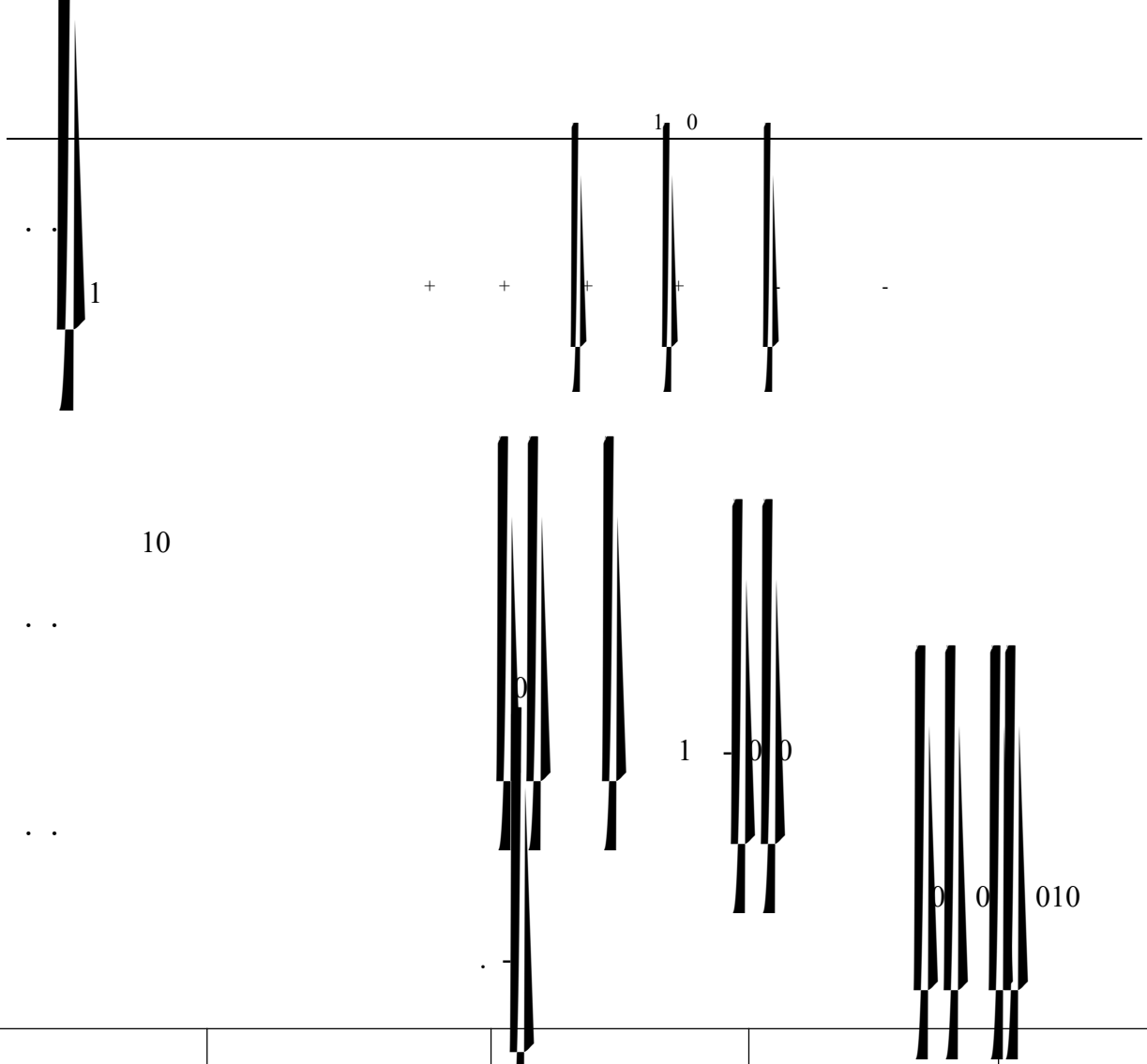

+	/ 11 0 -1			0.0 /
+	/ 11 0 -1			0.01 /
+	- 01			0.0 /
+	- 01			0.00 /
	/ 00 . - 0 1		--	.0 /
-	/ 00 . - 0 1		--	.0 /
	- 01			--
	/ 11 -1		--	0 /
	/ - 00			0 /
	- 00			0.0 /
	/ 0. - 00 (1.1)		--	0.0 /
	/ - 00			0.0 /
	/ -1			0.00 /
	0 - 00	-		0.000 /
	/ -1			0.0 /

	/ -1		--	.0 /
	/ 0. -00 (.1)			--
	/ -1			0.0 /
	-00	-		0.00 /
	1 -0 1			0.01 /
	0-01			0.01 /
	-01	/ -		1. /
	-01	/ -		1. /
-	-01	/ -		1. /
-	-01	/ -		/
	-01			0. /
	-01			0.0 /
	/ -1			0.00 /
	-01			0.00 /
	-01			0.00 /
	-01			0.0 /
	-01			0.00 /
	-01			0.0 /
	/ 0. -00 11.1			/
	/ 0. -00 .1			0. /
	-01			0.0 /
	/ 0.1 -00 (1.1)			--
	/ 0.1 -00 (1.1)			--





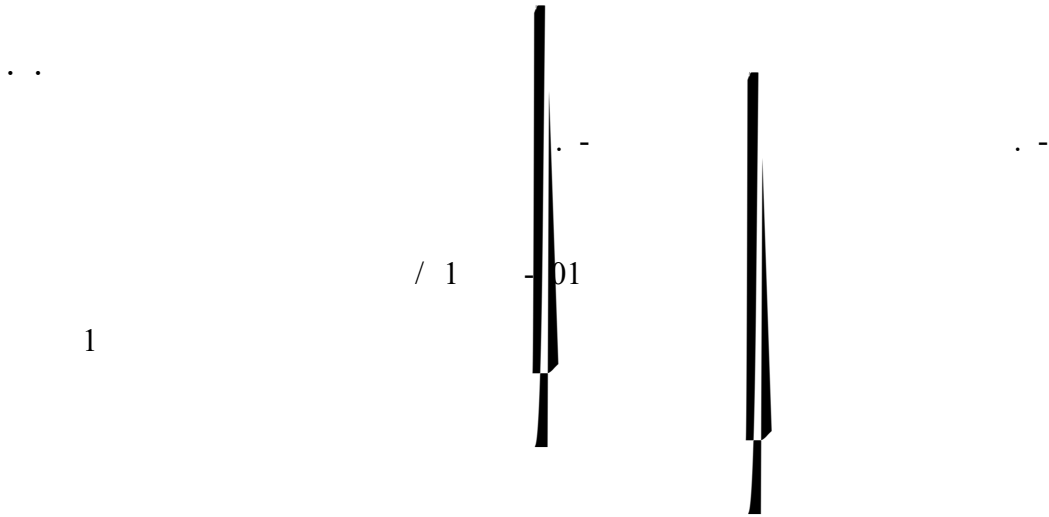















...

/ 1 -01



	1	1.1	1.0	1.1	1.	1.	1.	1.	1.0	10
	1.1	1.	1.0	1.1	1.	1.	1.	1.	1.0	1.
	1.1	.1	.	.	.	1.1	1.1	.1	1.1	.0

+	/	.	/	1 .	/	1.1	/	1.0	/	.1	/
+	/	.0	/	1.1	/	1.1	/	1.0	/	.1	/
+	/	10	/	1.1	/	1.1	/	1	/	.	/
+	/	1 1	/	1.1	/	1.1	/	0	/	1.0	/
+	/	.0	/	.0	/	.0	/	.0	/	.0	/
-	/		/	1.0	/	1.0	/	1.0	/	1.0	/
		.		.		.		.		.	
	/	1		.		1.1		.		.0	
	/	.0		1 .1		.0		1 .1		1.0	
	/	1 .		1.1		.		.11		1.1	
	/	. 1		. 1		.0		. 1		.0	
	/	0.0		0.0		0.0		0.0		0.0	
	/	0.00		0.00		0.01		0.00		0.0 1	
	/	0.000		0.000		0.000		0.000		0.000	
	/	0.0		0.0		0.0		0.0		0.0	
	/	1.1		1.1		1.1		1.1		1.0	
	/	.		1.1		1.0		1.1		1.1	
	/	0.1		0.		0.		0.1		0.	
	/	0.00		0.00		0.00		0.00		0.00	
	/	0.01		0.01		0.01		0.01		0.01	
	/	0.01	/	0.01	/	0.01	/	0.01	/	0.01	/

	/	1.		1.		1.		1.		1.
	/	1.		1.		1.		1.		1.
-	/	1.		1.		1.		1.		1.
-	/									
	/	0.000		0.000		0.000		0.000		0.000
	/	0.000 0		0.000 0		0.000 0		0.000 0		0.000 0
	/	0.00		0.00		0.00		0.00		0.00
	/	0.00		0.00		0.00		0.00		0.00
	/	0.00		0.00		0.00		0.00		0.00
	/	0.1		0.0 		0.0 		0.0 		0.0 
	/	0.0 1		0.0 0		0.01		0.00		0.00
	/	0.0		0.0		0.0		0.0		0.0
	/	0.00 		0.00 		0.00 		0.00 		0.00 
	/	0.000		0.000		0.000		0.000		0.000
	/	0.0 		0.0 		0.0 		0.0 		0.0 
	/	1 0		1  0		1 0		1 0		1 0
	/100									
1										

...



01  
01  
1

01  
1

1			1					
1			0					
			1					
			1			0		
						1		
10								
11								
1	/	/	0					
1			1					
1						0		
1						1		
1								
1						/	/	/
1						/	/	/

00  
01  
00  
1

000

	. 1	0.			0. 0		1.0	0. 0		0.1	0.		0.0 0.1
	.	0.		11	0.		0.	0. 1		0.1	0.		0.0 0.1
	.	0.		1	0. 0		1.0	0.		0.1	0.		0.0 0.1
	. 1	0.		1	0. 0		1.	0.		0.1	0. 0		0.0 0.0
	.	0.		1	0.		1.0	0.		0.1	0. 0		0.0 0.1

10 /

1 /

/

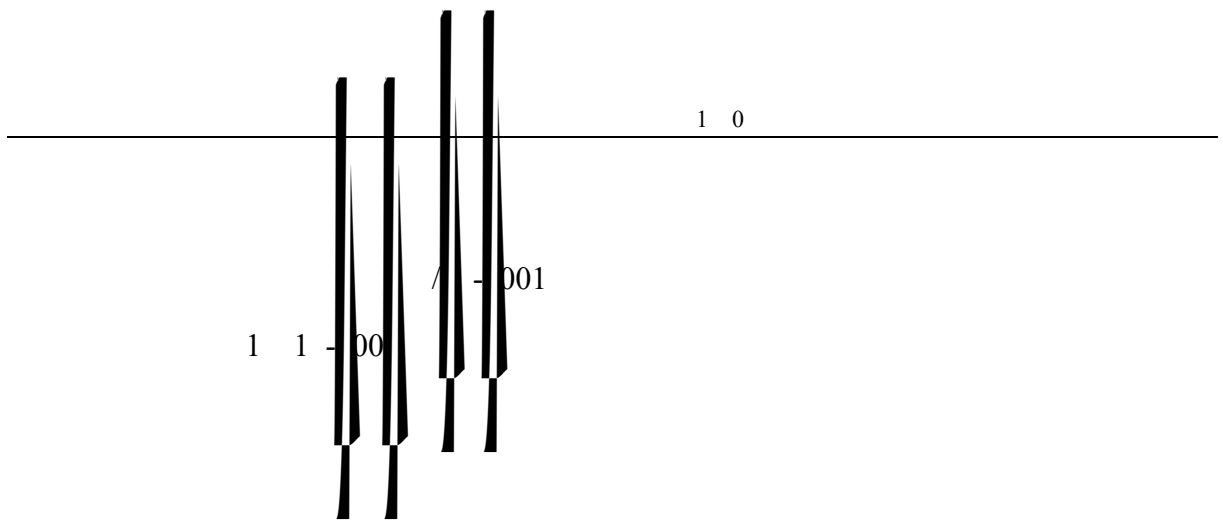

. .1

. -1      . -1

1	1	0			
1	1	100			
	1	1 0		0 00 00	0 1
	1	100		00 0 00	

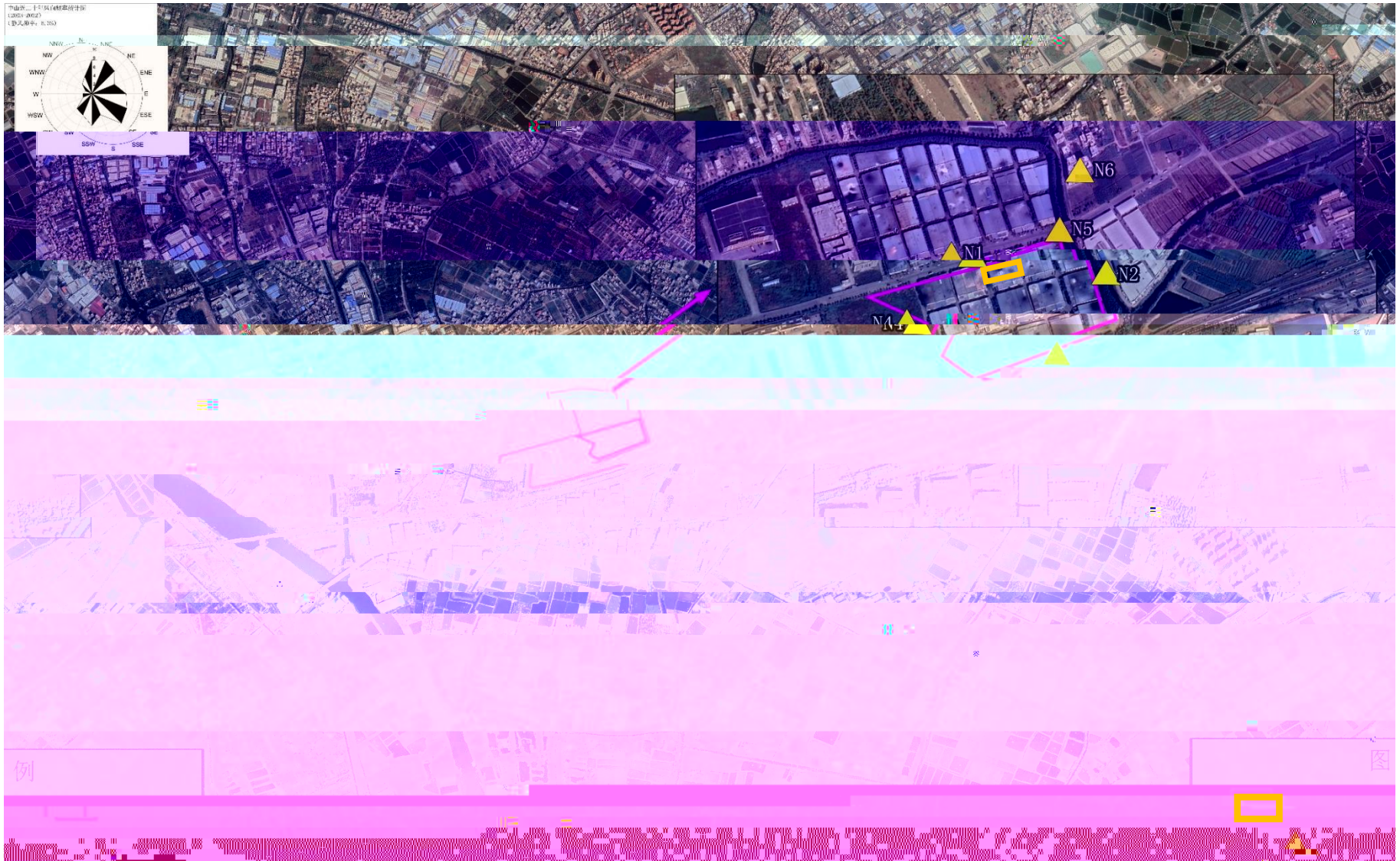

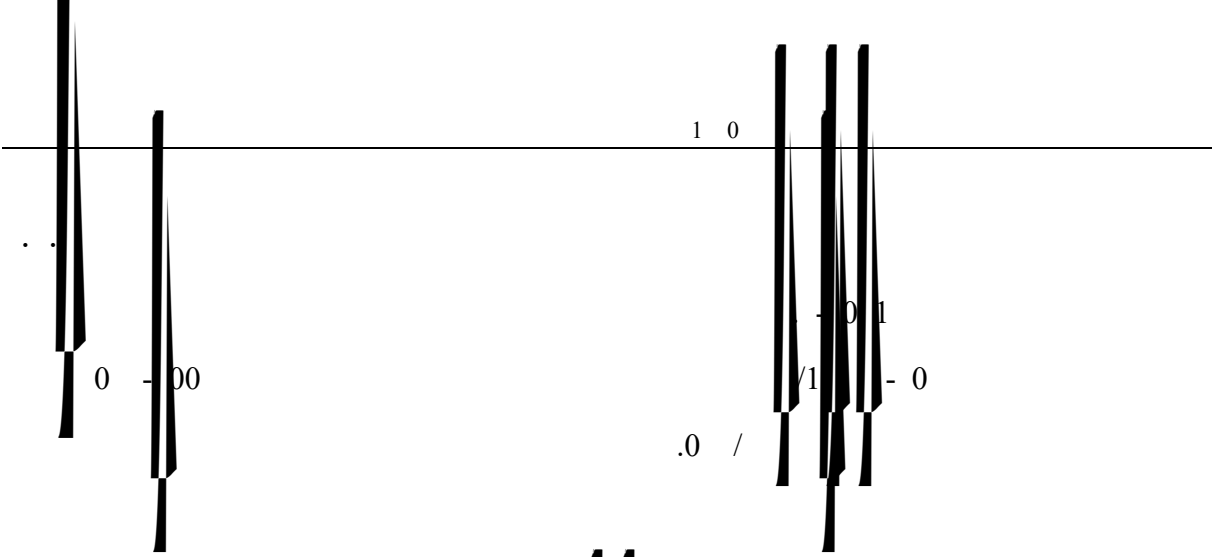

	0 00			
				--

..

1

..

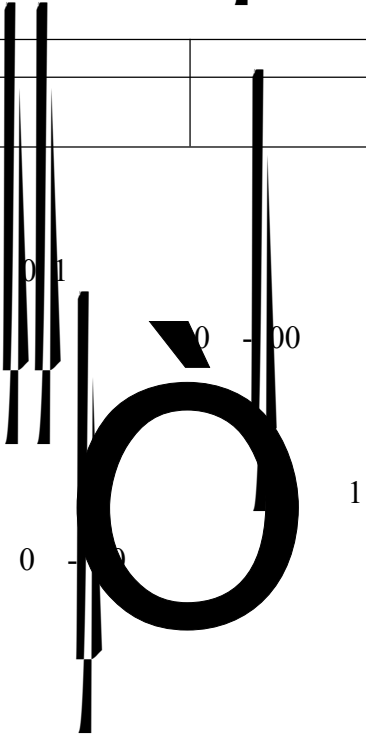

..

2

1

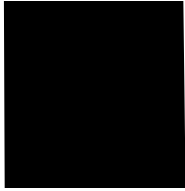
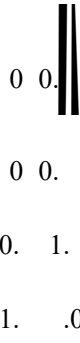
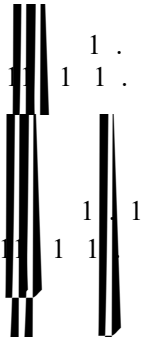

1  
1

©

(

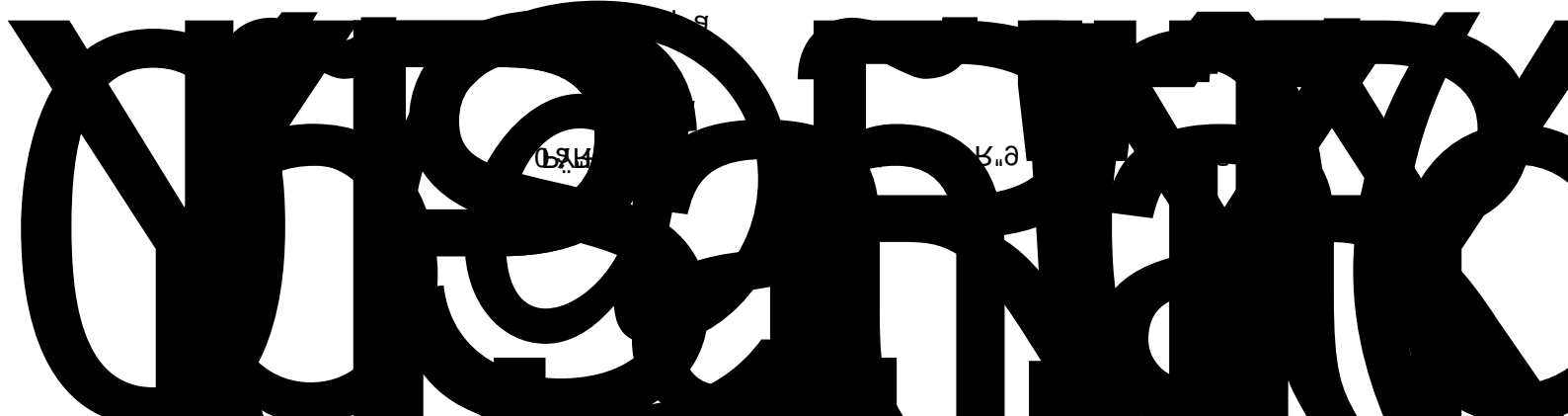

...

1

10- 0

/ 1 -00

	10 01			--
	10 01	-		0. /
	1- 01			/
	10 .1- 00			0.01 /
	/			0.01 /
	1 1 1-1			
	1- 01			1 /
	1- 01			10 /
	10 .1- 00			0.00 /
	1- 01			/
	1- 01			1 /
				1. /
				1.1 /
				1.0 /
1 1-				1. /
1 1-				1. /
1 1-				1.0 /
-1 1-				1. /
-1 1-				1. /
				1. /
1 1-	0 011	/	-	1.1 /
1 1 1				1. /
1 1				1. /
				1. /
1 1 1-				1. /
1 1 1-				1. /
				1. /
1 1 -				1. /



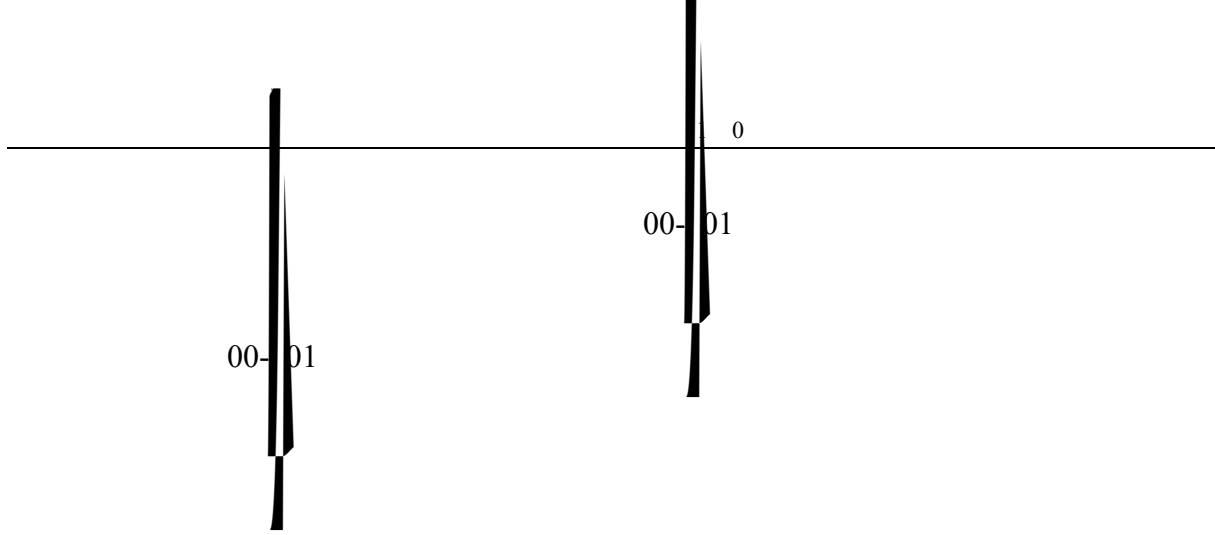









































		.	/		/	/
		0.	.		/	0.0
		1 .	0		/	0.
		1.0			/	0.01
		1	1 000		/	0.000
		1	00		/	0.0  1
		0.			/	0.00
			00		/	0.0
			/		/	/
		1. 10 <sup>-</sup>			/	0.000
		1.1 10 <sup>-</sup>	0.	0'00	/	0.000
		1.0 10 <sup>-</sup>			/	0.0000
1	1-	1.    10 <sup>-</sup>			/	0.0001
1		1. 10 <sup>-</sup>			/	0.0001
1	1-	1.0 10 <sup>-</sup>			/	0.0000
-1		1. 10 <sup>-</sup>			/	0.0000
-1		1. 10 <sup>-</sup>			/	0.0000
		1. 10 <sup>-</sup>	1		/	0.0000
		1.1 10 <sup>-</sup>			/	0.0001
1	1	1.    10 <sup>-</sup>	10		/	0.0001
1	1	1.    10 <sup>-</sup>	.		/	0.0001

	0.1	1.	/	0.0	
	0.1	1	/	0.00	
	0.1	1 1	/	0.000	
	0.1	1	/	0.0000	
	0.1	1.	/	0.0	
1 -	0.1	1	/	0.00	
	0.0	0	/	0.000	
10 <sup>-</sup> 0		00	/	0.00	
1					

				.0	.	.0	.	.	.	.01	.0	.	.
		/		/	/	/	/	/	/	/	/	/	/
				/	/	/	/	/	/	/	/	/	/
	/	.		0.	0.	0.	0.	0.	0.	0.	0.	0.	0.
				0.0	0.0	0.0	0.0	0.0	0.0	0.0	0.0	0.0	0.0
	/	0		1 .	1	1 .	1 .0	1 .1	1 .0	1 .	1	1 .0	1 .
				0.00	0.0	0.	0.	0.0	0.	0.	0.11	0.	0.
	/			0.	0.	0.1	0.0	0.	0.1	0.	0.	0.	0.0
				0.00	0.00	0.010	0.00	0.00 1	0.00	0.00	0.00	0.00 0	0.00
	/	1 000							1	1			1
				0.00	0.001	0.00	0.00	0.00 1	0.001	0.00	0.00	0.00	0.00

		1						0			
/	00	0.0	0.0	0.0	0.0	0.0 00	0.0	0.0	0.0	0.0 0	
		0.11		0.0	0.0		0.0	0.0	0.1 1	0.1	0.1
/		0.00 0	0.00			0.00	0.001			0.00 1	
							1	0			
/	00	0.0	0.0 	0.0 	0.0	0.0 00	0.01	0.0	0.0	0.0	0.0
		1 1	1		11	1	1		0	100	
/	/										

	/	0		1.11 10 <sup>-</sup>	1.11 10 <sup>-</sup>	1.11 10 <sup>-</sup>	1.11 10 <sup>-</sup>	1.11 10 <sup>-</sup>	1.11 10 <sup>-</sup>	1.11 10 <sup>-</sup>	1.11 10 <sup>-</sup>	1.11 10 <sup>-</sup>	1.11 10 <sup>-</sup>
				0.0000	0.0000	0.0000	0.0000	0.0000	0.0000	0.0000	0.0000	0.0000	0.0000
	/	0		1.11 10 <sup>-</sup>	1.11 10 <sup>-</sup>	1.11 10 <sup>-</sup>	1.11 10 <sup>-</sup>	1.11 10 <sup>-</sup>	1.11 10 <sup>-</sup>	1.11 10 <sup>-</sup>	1.11 10 <sup>-</sup>	1.11 10 <sup>-</sup>	1.11 10 <sup>-</sup>
				0.0000	0.0000	0.0000	0.0000	0.0000	0.0000	0.0000	0.0000	0.0000	0.0000
10 <sup>-</sup> 0	/	00		0	1	1				1	1	1	
				0.00	0.0	0.00	0.00 0	0.00	0.0100	0.00 1	0.00	0.00	0.00 1
				1									00-01

/	.	/	.10	/
.0	0.	0.0	0.	0.0
	1 .	0. 00	11.	0. 0
	0. 	0.0110	0. 	0.0 10
	1	0.01		0.0
00	0.11	0.0		0. 
1 0		0.01 1	0. 	0.0 1
/		0.1 00	1 0	0. 
	1. 10 <sup>-</sup>	/	1. 10 <sup>-</sup>	/
1		0.0000	1. 10 <sup>-</sup>	0.0000
	1. 10 <sup>-</sup>	0.0000	1. 10 <sup>-</sup>	0.0000
	1. 10 <sup>-</sup>	0.0000	1. 10 <sup>-</sup>	0.0000
		0.0000		0.0000
				

0

1/4

^ C

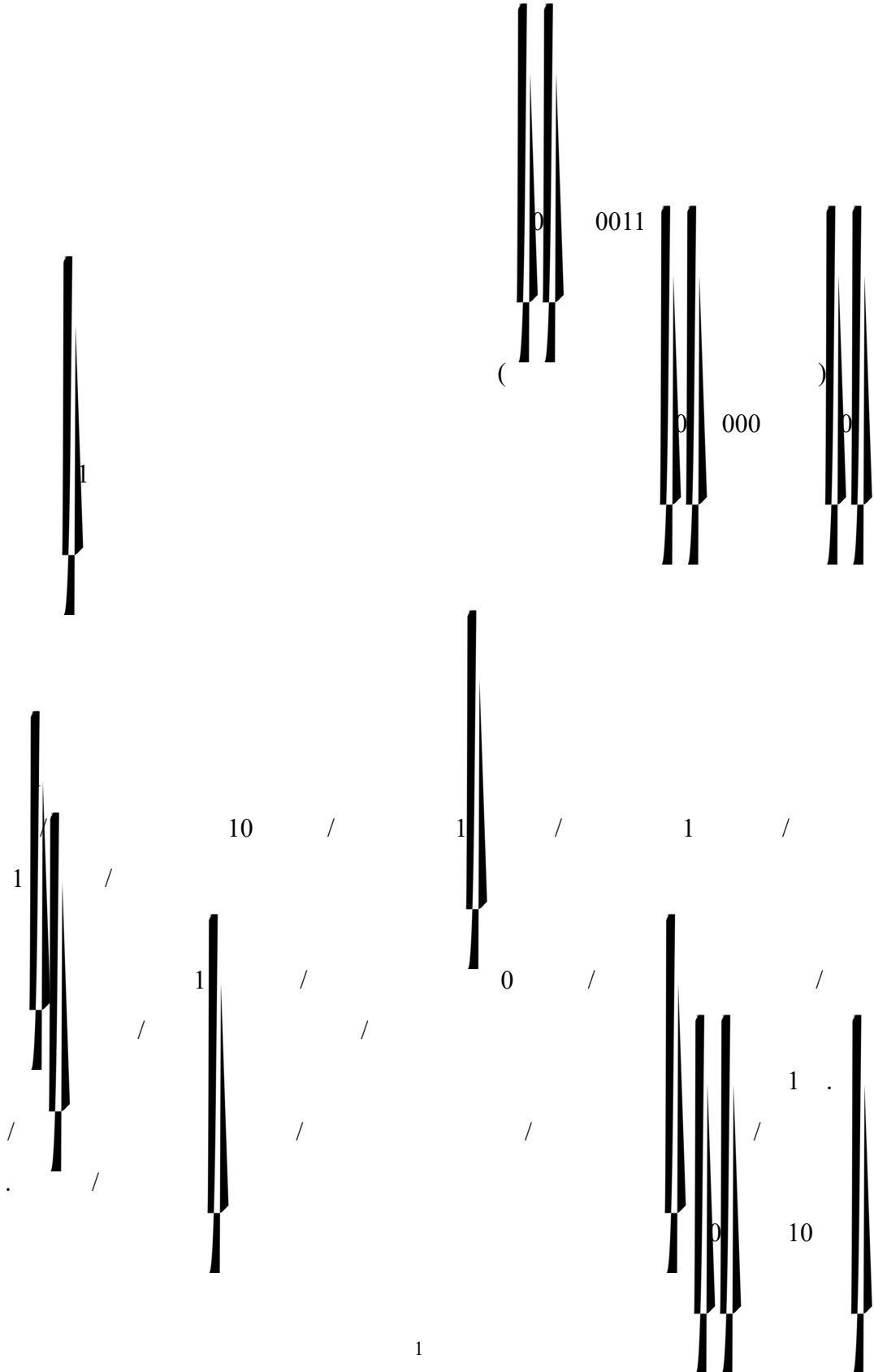

1 0

00 /

000 /

0

1

.0

5



1 .	1 .	1 .	.0	.	.	.	.	.	.1	.1	1.	1 .1
-----	-----	-----	----	---	---	---	---	---	----	----	----	------

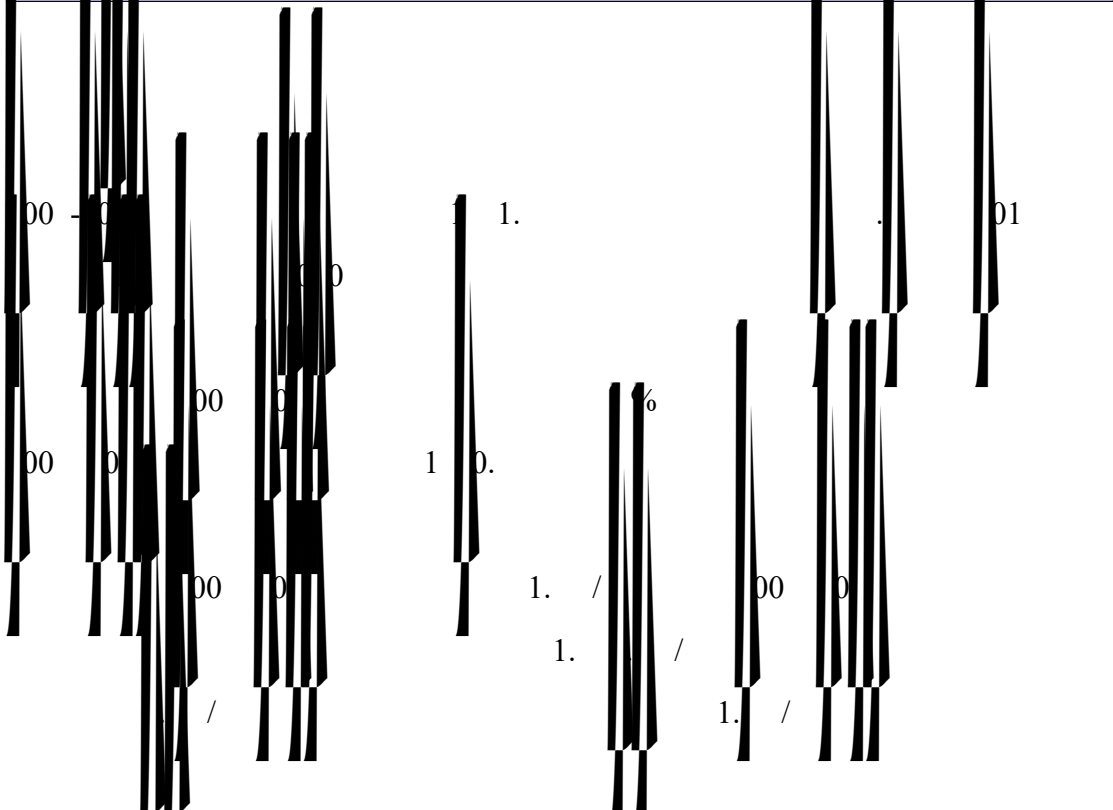
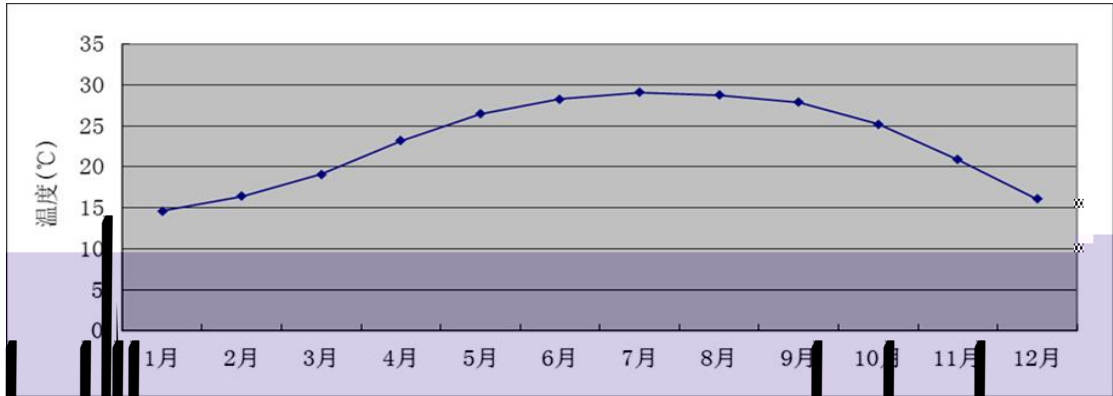

/	1.	1.	1.	.0	1				1.	1.	1.	1.	1.
---	----	----	----	----	---	--	--	--	----	----	----	----	----

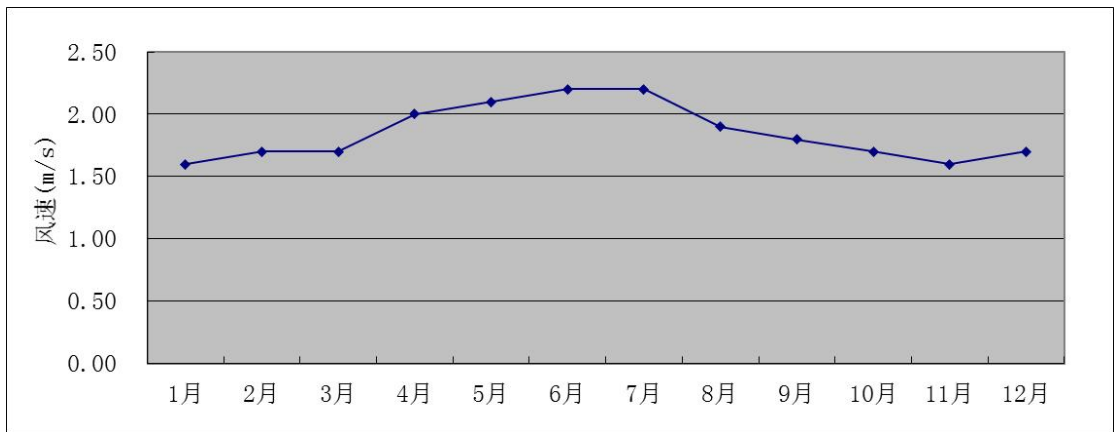



	/	0
	/	/
	/	/

[REDACTED]

(11 . [REDACTED] 0 )  
 (11 . [REDACTED] )  
 (11 . [REDACTED] 0 )  
 (11 . [REDACTED] 11 )

. /

1	0- 0			1 1 1 1	0.1	0.	1
1 1					0.1	0.	1
					0.1	1	1
				10 11	0.1	1	1



1



10

10

0. 0

0

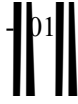

				( )	( )	( )	( / )	( )	/		/
		/	/	-1		1	1 .				0.0 0.01

			/					/
1	11 . 1 1		0	. 0				
							10	0.0
								0.0 0
								0.00

1

. + + +1.

1.

				/ ( / )	/	/
				0. 0.0	/	/

				( )	( )	( )	( / )	( )	/		/
		/	/	-1		1	1 .		1 0		0. 0.0

1 0

( 01 )

01

	1											
			10						1			
	( / )	%	( / )	%	( / )	%	( / )	%	( / )	%	( / )	%
10	0	0	0	0	. 1	1.0	. 11	11	0.	0.	. 00	
0	0.0	0.0	0.1	0.0	10.	1.1	10.	1	0.	0.	. 00	. 0
100	0.0	0.0	0. 0	0.0	. 1	0. 1	. 1	1.	0.	0.	. 00	0
00	0.0	0.0	0.1	0.0	.	0.	.	1.	0. 1	0. 0	.	1.
00	0.1	0.0	0.	0.1	. 1	0.	. 1	0.	0.	0.1	.	1.1
00	0.1	0.0	0. 1	0.1		0.		0.	0. 0	0.10		0.
00	0.1	0.0	0.	0.1		0.		0. 1	0.1 1	0.0	. 01	0.
1000	0.1	0.0	0. 0	0.10	0.	0.11	0.	0.	0.0 0	0.0	0.	0.
1 00	0.0	0.0	0. 10	0.0	0.	0.0	0.	0.1	0.0	0.0	0.	0.1
000	0.0	0.0	0.1	0.0	0. 0	0.0	0. 0	0.0	0.0	0.01	0.	0.1
00	0.0	0.0	0.11	0.0	0. 0	0.0	0. 0	0.0	0.0	0.01	0.	0.0
	0.1	0.0	0.	0.1	1. 0	1. 0	1. 0		0.	0.	11.0 0	.
	1											
10%( )	/											

		( / )	( / )	(%)		10% ( )
		00.0	0.1	0.0		/
		00.0	0.	0.1		/
1		00.0	1. 0	1. 0	1	/
	10	0.0	1. 0		1	/
		00.0	0.	0.	1	/

		00.0	11.0 0	.	1	/
--	--	------	--------	---	---	---

	i( / )	i %	( / )	%
0	0.1	0.0	1.	0.
100	0.1	0.0	.01	0.
.00	0.1	0.0	1.	0. 1
.00	0.	0.1	.	1.
.00	0. 1	0.1	.0	1.
.00	0.	0.1	.	1.1
1000	0. 1	0.1	.00	1.00
1 00	0.1	0.0	.0 0	0. 0
.000	0.1	0.0	1. 0	0. 0
.00	0.0	0.0	1.1	0.
	0. 1	0.1	.	1.
( )				
10%( )	/			

	( / )	( / )	(%)	( )	10% ( )
	00.0	.	1.		/
	.00	0. 1	0.1		/

1	/		1100	0.0	0.1
			00	0.01	0.0
/	/	/	/	/	/
					0.1
					0.0
					0.1
					0.0

1	1#	#	/	/	-001	1.0
						0.1
						1.0
						1.0
						0.0
						0.1

		0.01
		0.1

1		0.1	0.1	0.
		0.0	0.01	0.0
		/	0.1	0.1



		0	0	

||+

||000 /

00 ||000 /

00 /



|||b

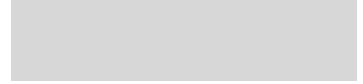

)B

||000 /

0

0

100%

100%

10%

10%

0%

0%

1

100%

100%

)B

||-0%

||-0%

b

01

1

1

1 0 /

/ - 001

0 . /

+

"

"

+

+

+

1

+

1

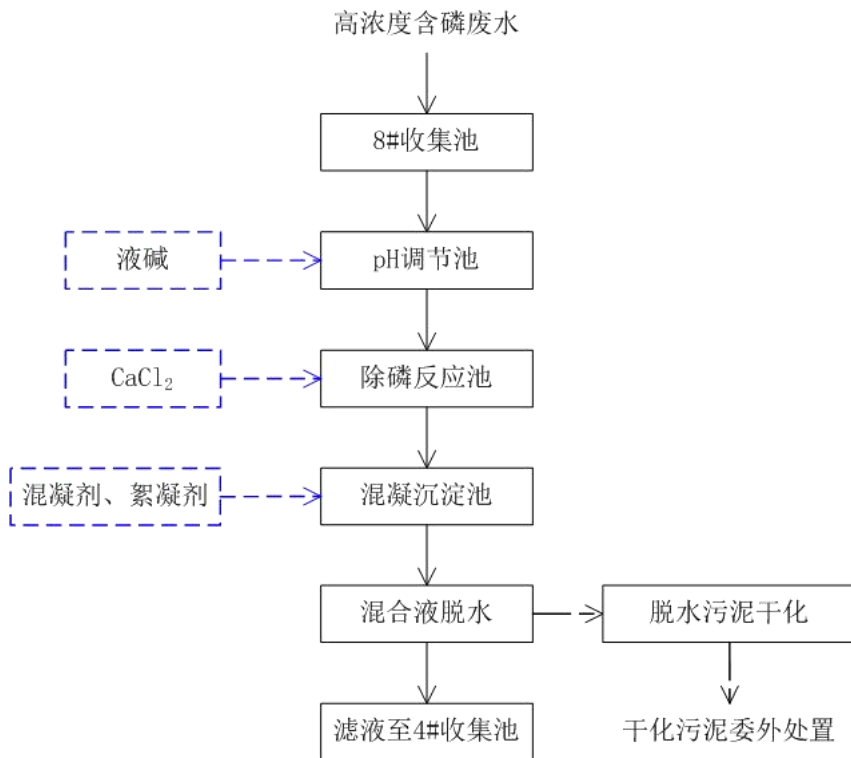
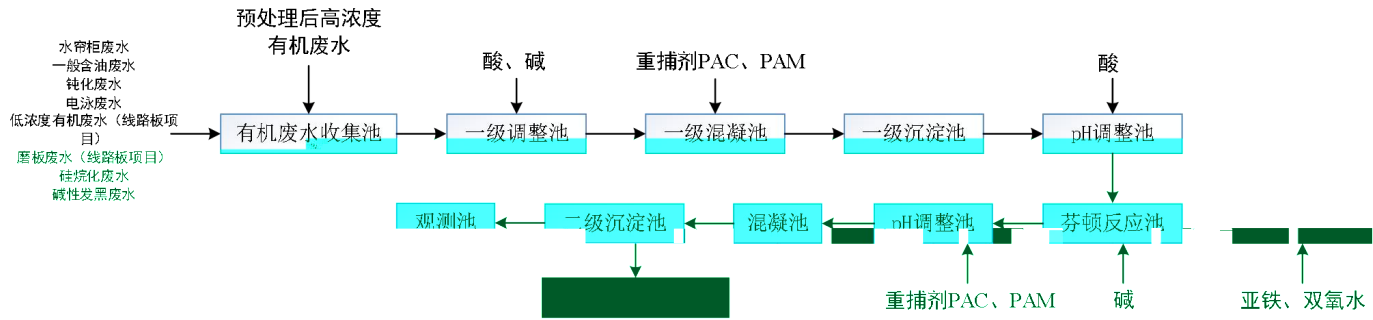
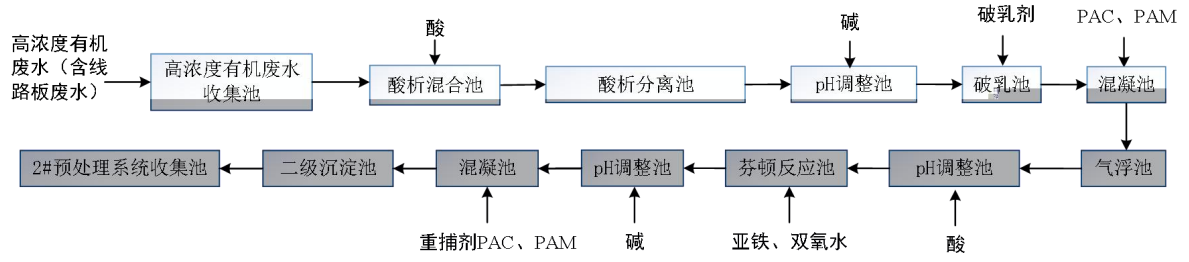

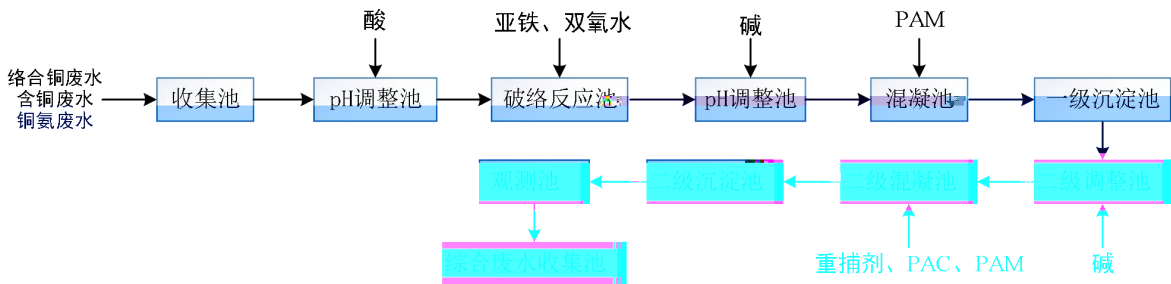
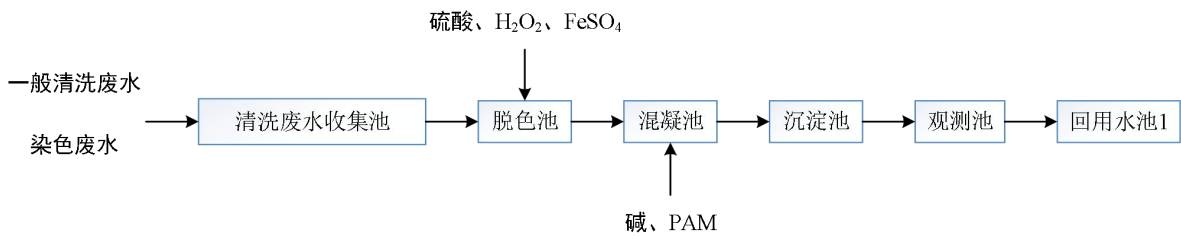
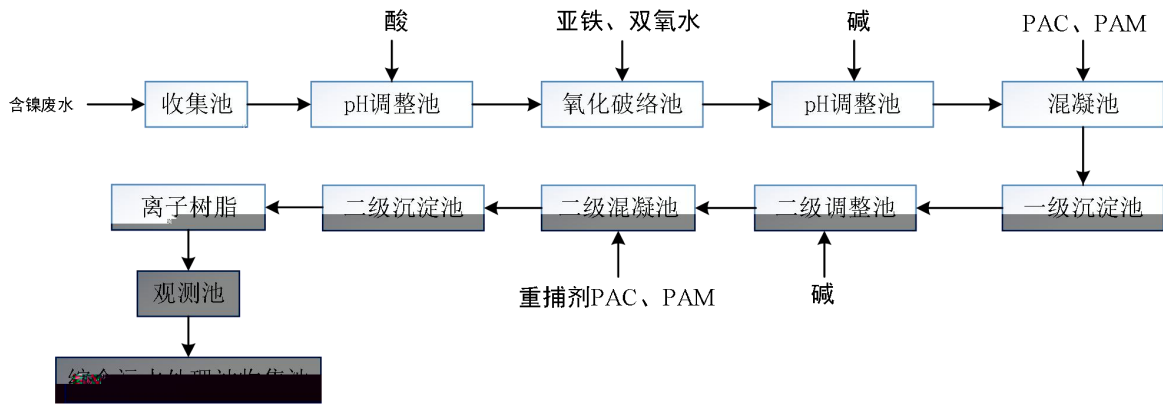
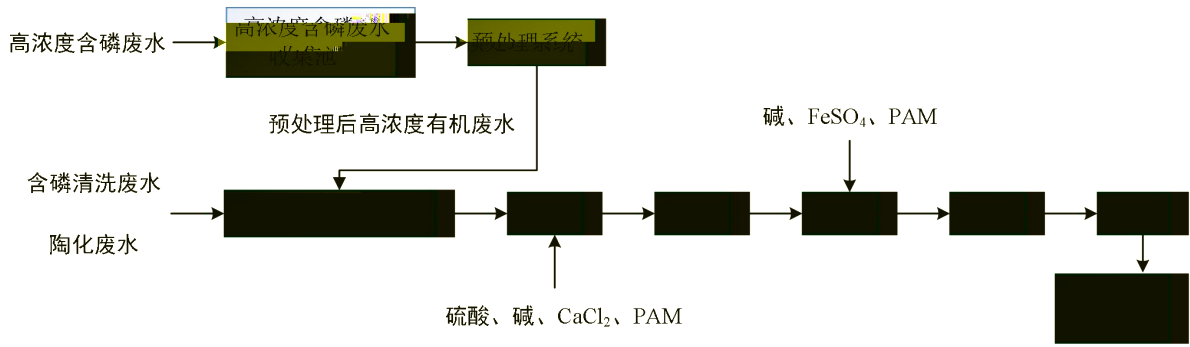

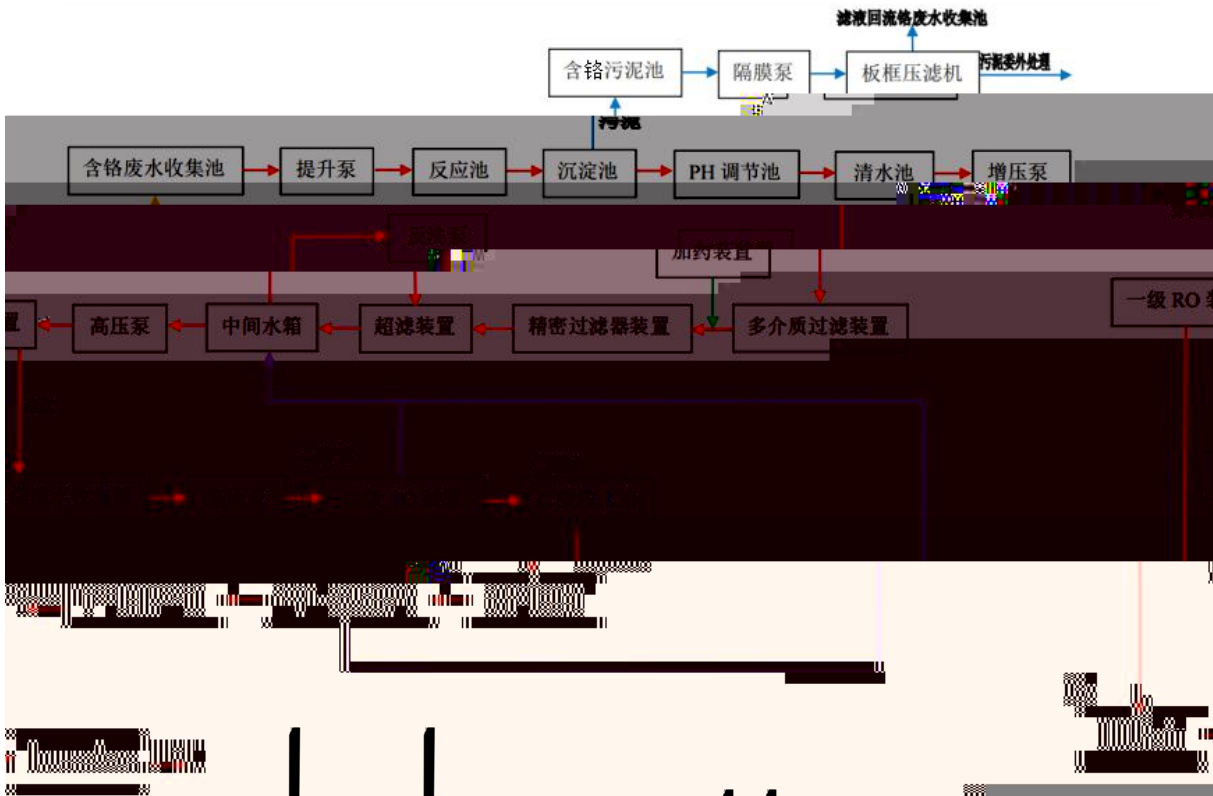
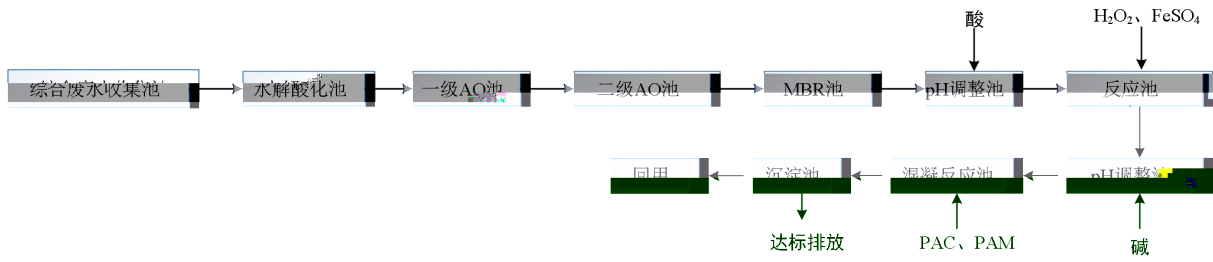

/1 -01

-001

1		0.1	
II	/	0.	
	/	1.0	
	/	0	
	/	0	

	/	0	
	/	0	
	/		
10	/	1	
11	/	0.	
1	/	0	
1	/	10	
1	/	.0	

/ 1 - 00

"

"

1  
||

/

. . .

0

10

0

0.

0.1

|| 0

0

10

11

|| /

o/10

/

1 0 /

( )

1#			100	/	/
#			00	/	/
			0	10.	%
			100	/	/
			100	/	/
#		0	/	/	
#			100	.	. %
			0	/	/
#			100		%
#			00	11.	%
			1 0		1. %
#			100	1.	1.
#			0	/	/
			0	1.	1. %
#			1	.	0%
			01	1	0 %



										10
	/	/	/	1.			/		-	0 0 0 0 0 0 0 0 -

										/ /
1	/									0
										10
										10
										0
	/									0
										/
										0

				0.
				1
				0
				1.0
				0.
				1.0
				0
				-
			001	

			/ /	/ /	/ /
1	0 /		0	0. 888	0.
	1 0 /		1 0	0. 525	0.1
			1 0	0. 485	0.1 1
		-		0. 101	0.0
			/	/	/
			/	17. 157	.
	0 . /		/	0. 824	0.
		-	/	0. 676	0. 11
			/	0. 724	0.



		0%	0%

---

				/ /	/ /
			.		/
			0.		/
		-	0.		/
			0.		/
			1.		/
			0.00		/
			0.		/
			0.0		/
			0.0		/
			0.0		
			0.0 0		
			0.1		
				/ /	/ /

---

		/	/	/		
		/	/	/		

1

1

1

1

1

1

1

1

0.

1.

00

10

.10

.0

1.

10 /

1

0

0

/

1.1

1b

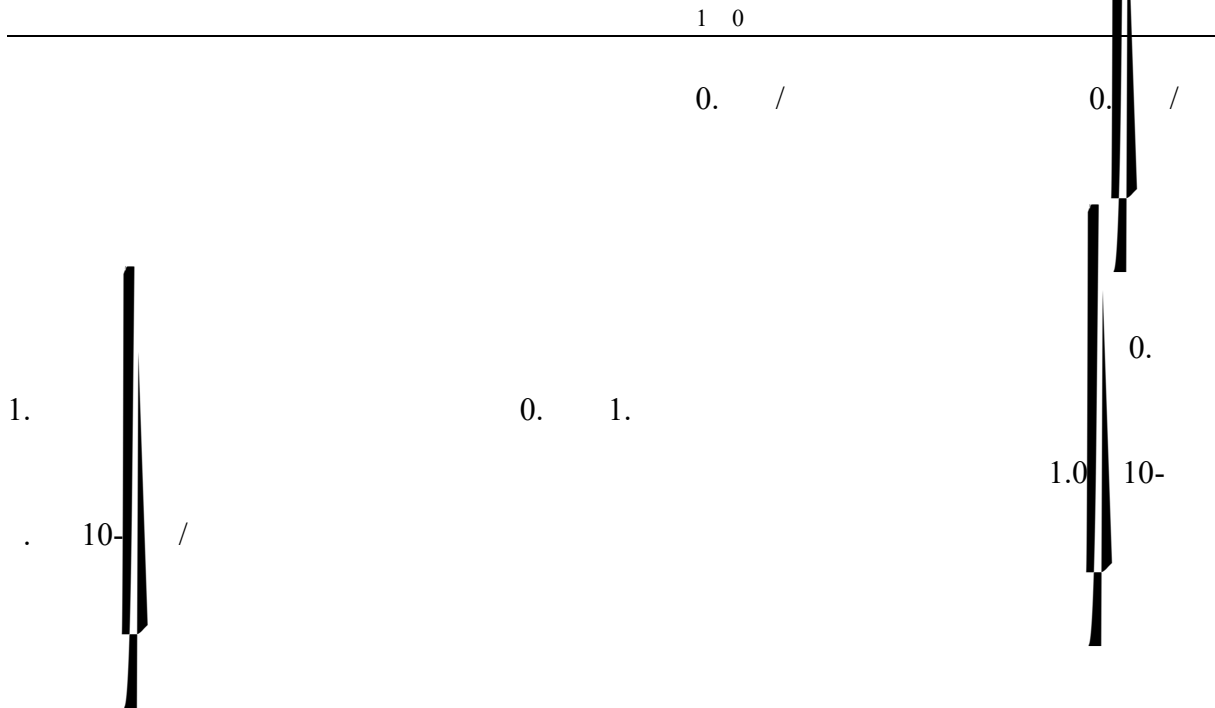

1 00 1 00

1 1 .



lb



1



()

() +

+ + + +

0

()

() (0)

()

$$L_A(r) = 10 \lg \left\{ \sum_{i=1}^8 10^{[0.1L_{p_i}(r) - \Delta L_i]} \right\}$$

()

()

() (0)

. -1

00

1

1 ( + )

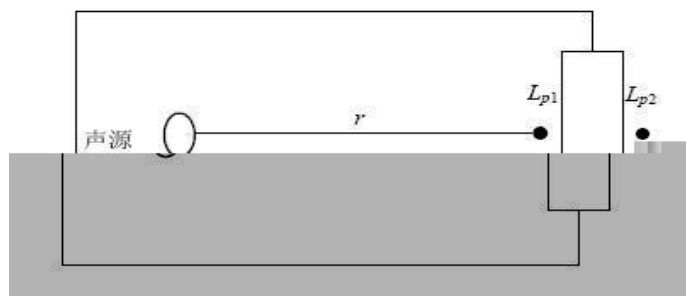



. -1

1 -00

1 -00	

0

			( / ( )// )	/			/	/ ( )		/ ( )		
											/ ( )	
1			/1	-1	-10	1	10				0	1
		1#	/1	1	-10	1	10				0	1
		#	/1	0	-10	1						1
			0/1	0	10	1						1
			/1	0		1						1
			0/1	0	0	1						1
			/1	-1	-10	1						1
			0/1	-1	0	1						1

.

1	1					.	/	/	/		
	1					.	/	/	/		
	1	0	0			1.	/	/	/		
	1					0.	/	/	/		

1 - 00

		.	/
		0.0	/
		1 . 1	/
		0.	/

		.	00-0 1-	
	/	0.1 /		
		1 . /	1	
			-0 -1	

6



10

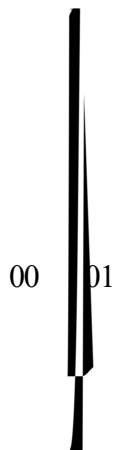

	/				

1

1

- - /

/

-01



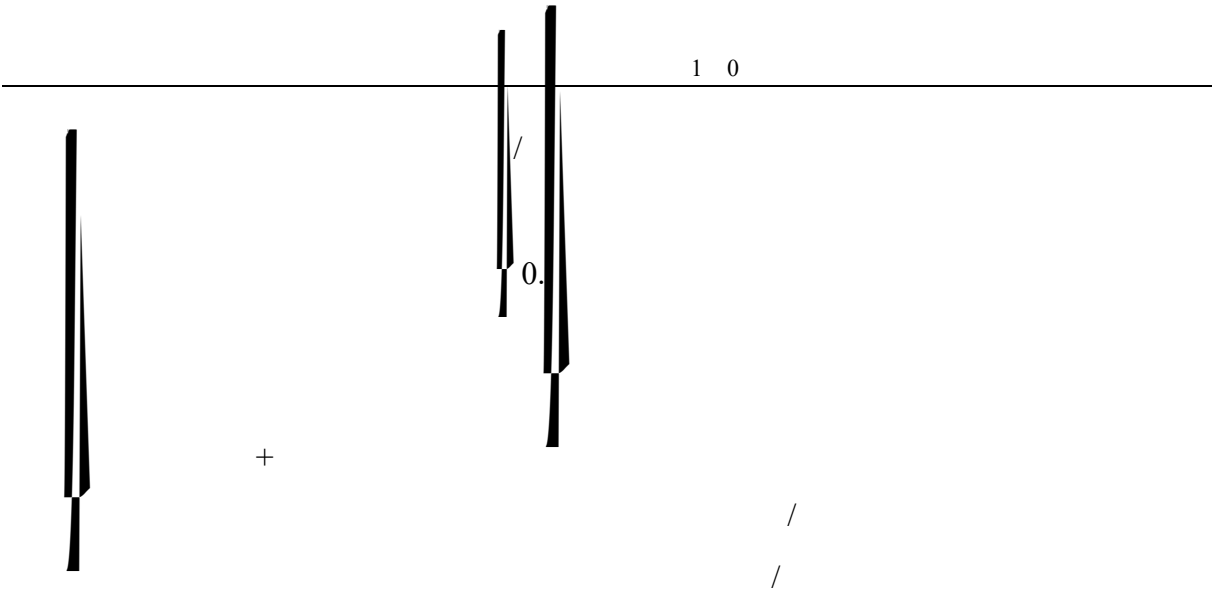

/

|| 000

0

0

/ 11 0

|| 000000

0. ||

0.1 /

□

11 0 / 1.1 -1. /

|| 000000

$10^{-10}$  /



/

IIIb

1  
 - 0  
 0 000 01 / 1 - 01

			0.	
		)	)	
			0	0-0.
		-1,	-1,	1,
		1,1,	1,	1,
		1,1,	1,	1,1,1-
		1,	1,	
		1,	1,	
		1,	1,	
		1,	1,	
		10-	0	



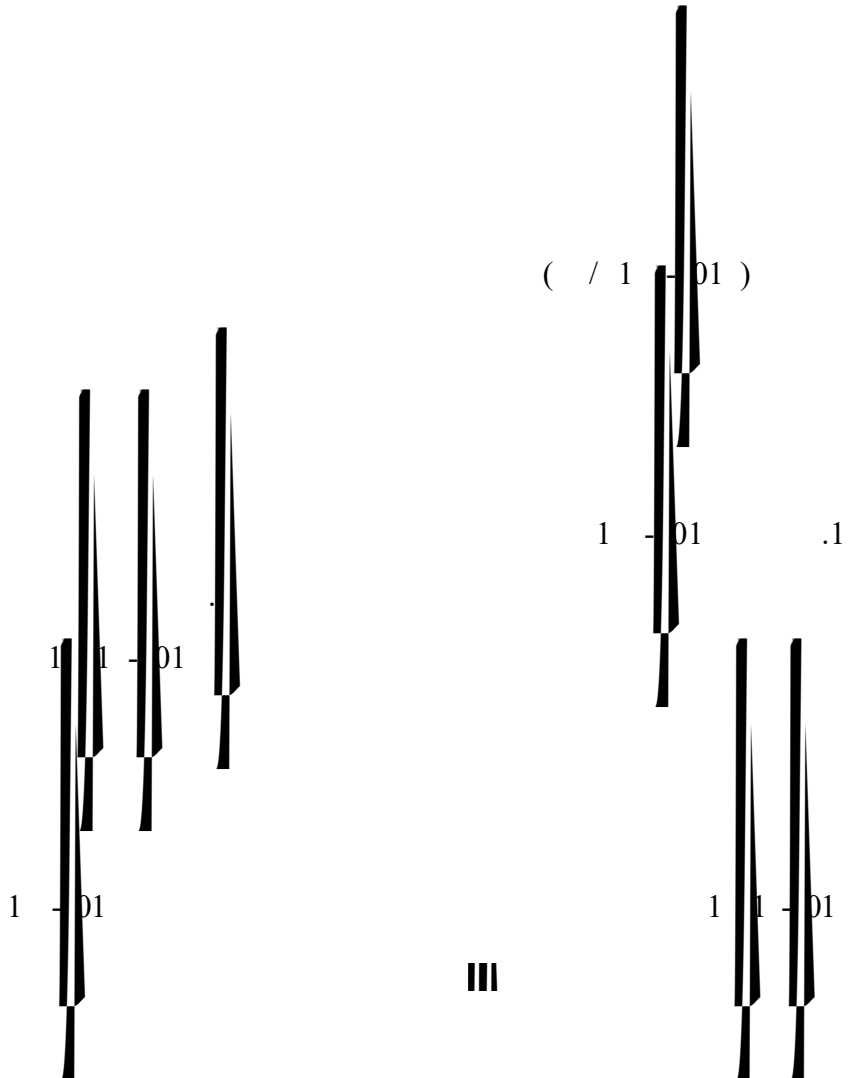



		1 00* 00*1 00	0.	1	0	0	11 0		0.	0	1.1	0	0
		00* 00*1 00	0.					0. 00	0.000	0	0.000	0	0.000
		00* 00*1 00	0.					10	0.000	0	0.000	0.0 00	0.0000
		1 00* 00*1 0	1.	1				0. 00	0.000	0	0.000	0.000	0.000
		00* 00*1 00	0.	1	00	0	00		0. 00	0	0. 00	0.000	0.0000
		00* 00*1 00	0.	1				0. 00	0.000	0	0.000	0.000	0.0001
		00* 00*1 00	0.	1	00	0	00		0. 00	0	0. 00	0.000	0.0000
1#		00* 00*1 00	0.	1	1 0	1	0		0.100	0.010	0.000	0.000	0.0000
		1000* 00*1 00	0. 00	1	0	0	11 0		0.	0.000	0.	0.000	0.0000
		000*1000*1 00	0. 00	1	0	0	11 0		1.1	0.000	0. 00	0.000	0.0000
		000*1000*1 00	0. 00	1	1 0	1	0		0. 10	0.0 1	0.000	0.000	0.0000
		000*1000*1 00	0. 00		00	0	0		1.	0.000	0.000	0.000	0.0000
		000* 00*1 00	1.					10	0.000	0.000	0.000	0.0	0.0000
		00* 00*1 00	0.					10	0.000	0.000	0.000	0.0 00	0.0000
#		1 00* 00*1 00	1.	1	0	0	11 0		0. 00	0.000	1. 00	0.000	0.0000
		1 00* 00*1 00	1.	1	1 0	1	0		0. 00	0.0 00	0.000	0.000	0.0000
		1 00*1000*1 00	1. 00		00	0	0		1.1	0.000	0.000	0.000	0.0000
									.	0.0	.0 00	0.10	0.000





1



-		0.		.	0.035
-	-	.		10	0.730
-		.	0	10	0.851
/		0.1	1	0.	0.528
/		0.00		0.	0.013



		10
00	10.0	

1

100	1	1		
10 100	1			
1 10				

1

1

1		00		1000
		00	00	1000
		00	100	

1	00 100 00 00

1

	1		
1	1	1	
	1		
	1		

1	

1	10
	10

	10 1



10

1

1

1	1	1	
	1		

1	



1 0

--	--	--	--	--

1 - 01

1		

1		



/

			( ) ( )

1.

||



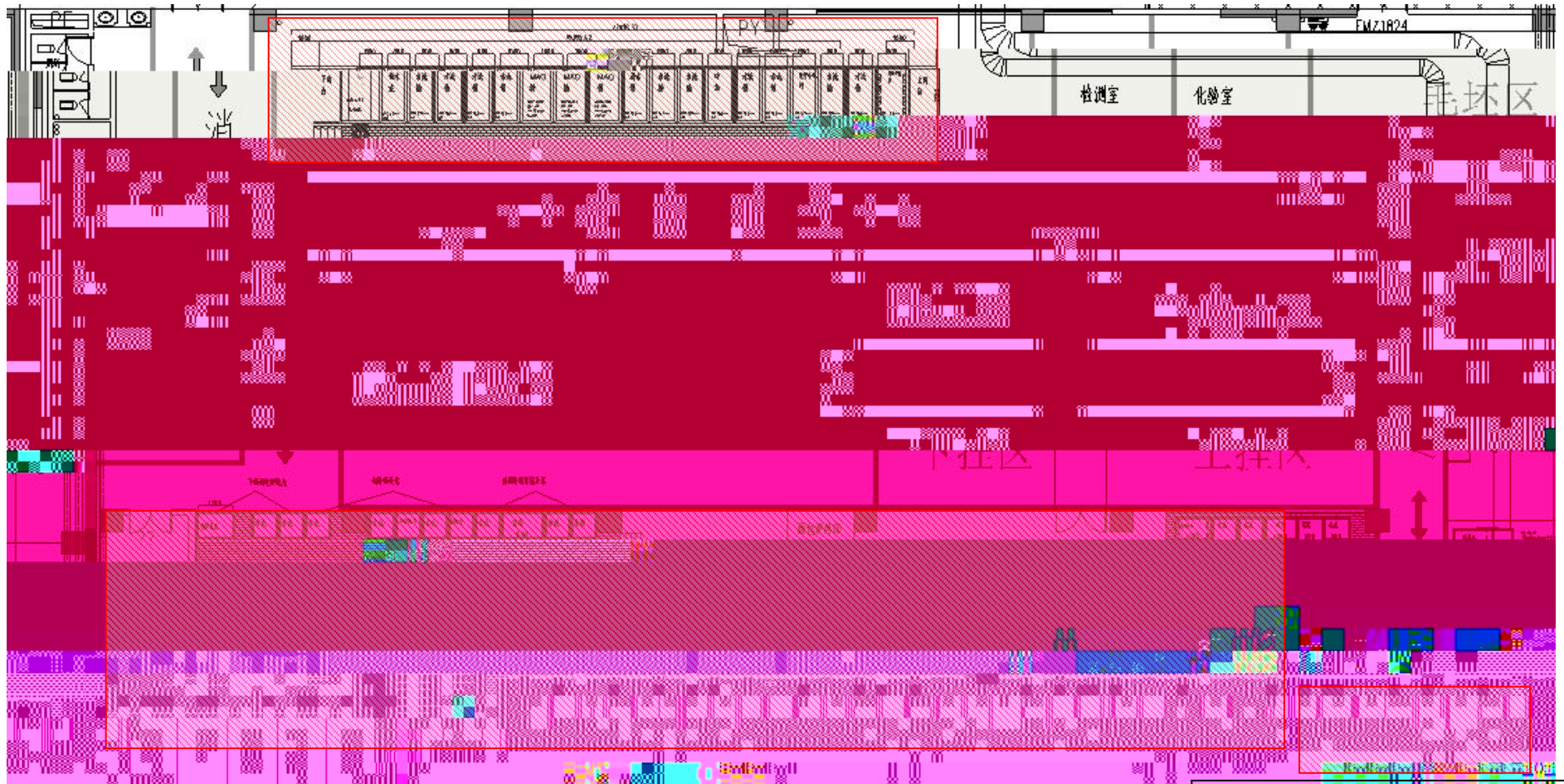

1.



1						

---

					1	
					1	

/

/

/

--	--	--	--	--

	*			
	*			
	*			



10

0

0

10



0.0 10 /

0

0

0



0

1 - 01

0.

10

$$Q_L = C_d A p \sqrt{\frac{2(P - P_0)}{\rho} + 2gh}$$

.1

0.

1 01

0

\* \*0.1

1.

\* \*0.1

		0						
	101	101	1 0	. 1	0.	0.	. -0	0.
	101	101	1 0	. 1	0.	0.	. -0	0.0
	101	101	1 0	. 1	0.	0.	. -0	0.

1

0. /

0.0 /

0. /

	/		
0.		0	
0.0		0	0
0.		0	

0

1 - 01

$$Q_3 = \alpha p \frac{M}{RT_0} u^{\frac{(2-n)}{(2+n)}} r^{\frac{(4+n)}{(2+n)}}$$

/

1 - 01

,

.

/

0

/

/

( 1 - 01 ) .1.1.

1. /

0%

( 1 - 01 )

1 - 0

0

0

					0				
	0.00	0.	.	. 1	.1	0.0	1.	1.	0.00000
	0.00	0.	.	. 1	.1	0.0	1.	1.	0.00000
	0.00	0.	00	. 1	.1	0.0	1.		0.000 0 0

0.00000 /

0.0000 /

0.000 0 0 /

1	*			0.	0		0.00000	/	
1	*			0. 0	0	0	0.0000	/	
1	*			0.	0		0.000 0 0	/	

1 - 01

1

/

$$R_i = \frac{\text{烟团的势能}}{\text{环境的湍流动能}}$$

$$R_i = \frac{\left[ \frac{g(Q / \rho_{rel})}{D_{rel}} \times \left( \frac{\rho_{rel} - \rho_a}{\rho_a} \right)^{\frac{1}{3}} \right]}{U_r}$$

$$R_i = \frac{g(Q_t / \rho_{rel})^{\frac{1}{3}}}{U_r^2} \times \left( \frac{\rho_{rel} - \rho_a}{\rho_a} \right)$$

/

/

/

10

/

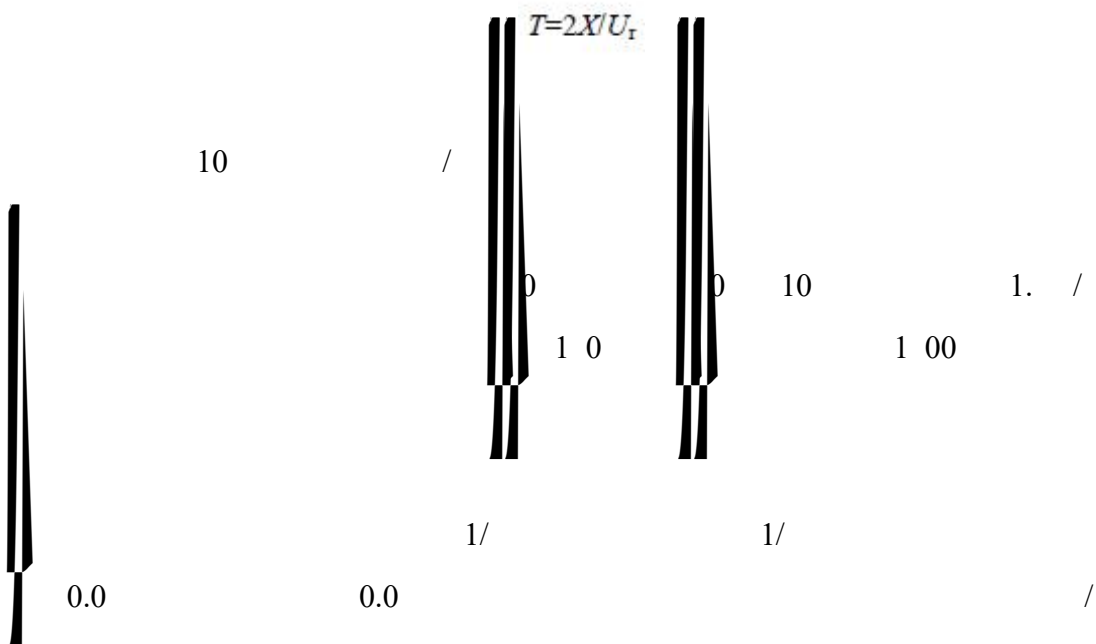

	/	/	/	/	/	
	1 0.		1.1	0.00000	.	0.0101
	1 0	.	1.1	0.0000		0.0
			1.1	0.000 0 0		0.0

0.0101

.0

0.0

1/

/ 1 - 01

	1 0	.
	1 0	0
	0	0
		/ 1 - 01

1 - 01

1. /

0%

	/( )	11 1 0.
	/( )	1.1

	$f( / )$	1.
	/	
	/%	0
	/	100
	/	/

10	.111	0				
110	1.	1. -0				
10		.0 -0				
10	.	1.0 -0				
10	.	1.1    -0				
10	.	1.0    -0				
10	.	. -0				
10	.	. 0 -0				
10	.000	. -0				
10	10.111	. -0				
1010	11.	.0 -0				
1110	1	. -0				
10	1 .	. -0	1 0	/	.	/
1 10	1 .	. -0				
1 10	1 .	.1 -0				
1 10	1 .	0 -0				
1 10	1 .	-0				
1 10	1 .000	-0				
1 10	0.111	-0				
1 10	1.	1 -0				
010		0 -0				
110	.	1.    -0				
10	.	1. 1 -0				
10	.	1. 1 -0				
10	.	1.    -0				

10	.	1. -0			
10	.000	1. -0			
10	.111	1. 0 -0			
10	.	1. -0			
10	0.	1. -0			
010	1.	1. -0			
110	.	1.1 -0			
10	.	1.1 -0			
10	.	1.0 -0			
10	.	1.0 -0			
10	.000	1.01 -0			
10	0.111	. 0 -0			
10	1.	. -0			
10	.	.0 -0			
10	.	. -0			
010	.	. -0			
110	.	.1 -0			
10	.	. -0			
10	.	. -0			
10	1.000	. -0			
10	.111	. -0			
10	.	.0 -0			
10	.	. -0			
10	.	.0 -0			
10	.	. -0			

-1

-1

	( )	1	11	1	1	1	1	1	1	1	1	1	101
1	1. -0 11	0.00 +00	1. -0	1. -0	1. -0	0.00 +00	0.00 +00	0.00 +00	0.00 +00	0.00 +00	0.00 +00	0.00 +00	0.00 +00
1	1.1 -0 11	0.00 +00	1.1 -0	1.1 -0	1.1 -0	0.00 +00	0.00 +00	0.00 +00	0.00 +00	0.00 +00	0.00 +00	0.00 +00	0.00 +00
	. -0 11	0.00 +00	. -0	. -0	. -0	.10 -0	0.00 +00	0.00 +00	0.00 +00	0.00 +00	0.00 +00	0.00 +00	0.00 +00
	. -0 11	0.00 +00	. -0	. -0	. -0	.0 -0	0.00 +00	0.00 +00	0.00 +00	0.00 +00	0.00 +00	0.00 +00	0.00 +00
	1. -0 1	0.00 +00	0.00 +00	0.00 +00	1. -0	1. -0	1. -0	1. -0	1 -0	0.00 +00	0.00 +00	0.00 +00	0.00 +00
	1. 1 -0 1	0.00 +00	0.00 +00	0.00 +00	. 1 -0	1. 1 -0	1. 1 -0	1. 1 -0	. 0 -0	0.00 +00	0.00 +00	0.00 +00	0.00 +00
	1. 1 -0 1	0.00 +00	0.00 +00	1. 1 -0	1. 1 -0	1. 1 -0	1. 1 -0	1. 1 -0	0.00 +00	0.00 +00	0.00 +00	0.00 +00	0.00 +00
	1. 1 -0 1	0.00 +00	0.00 +00	1. 1 -0	1. 1 -0	1. 1 -0	1. 1 -0	1. 1 -0	0.00 +00	0.00 +00	0.00 +00	0.00 +00	0.00 +00
	1. 1 -0 1	0.00 +00	0.00 +00	0.00 +00	1.1 -0	1. 1 -0	1. 1 -0	1. 1 -0	. -0	0.00 +00	0.00 +00	0.00 +00	0.00 +00
10	1.10 -0 1	0.00 +00	0.00 +00	0.00 +00	. -0	1.00 -0	1.10 -0	1.0 -0	. 1 -0	0.00 +00	0.00 +00	0.00 +00	0.00 +00
11	. -0 1	0.00 +00	0.00 +00	0.00 +00	1. -10	. -0	. -0	. -0	. -0	. 1 -0	0.00 +00	0.00 +00	0.00 +00
1	. -0 1	0.00 +00	0.00 +00	0.00 +00	. -1	1. 1 -0	.11 -0	. -0	. 1 -0	. 1 -0	0.00 +00	0.00 +00	0.00 +00
1	1.01 -0 1	0.00 +00	0.00 +00	0.00 +00	1.01 -10	. -0	1.01 -0	1.01 -0	. 1 -0	0.00 +00	0.00 +00	0.00 +00	0.00 +00
1	1.1 1 -0 1	0.00 +00	0.00 +00	0.00 +00	1. -0	1.0 -0	1.1 1 -0	1.1 1 -0	. -0	0.00 +00	0.00 +00	0.00 +00	0.00 +00
1	1. 1 1 -0 1	0.00 +00	0.00 +00	0.00 +00	. 1 -0	1. 1 1 -0	1. 1 1 -0	1.1 -0	1. 1 1 -0	0.00 +00	0.00 +00	0.00 +00	0.00 +00
1	. -0 1	0.00 +00	0.00 +00	0.00 +00	1.01 -10	. 1 -0	. -0	. -0	. 1 -0	0.00 +00	0.00 +00	0.00 +00	0.00 +00
1	. -0 1	0.00 +00	0.00 +00	0.00 +00	1.01 -10	. 1 -0	. -0	. -0	. 1 -0	0.00 +00	0.00 +00	0.00 +00	0.00 +00
1	1. 1 1 -0 1	0.00 +00	0.00 +00	0.00 +00	1.0 -0	1. 1 1 -0	1. 1 1 -0	1.1 1 -0	0.00 +00	0.00 +00	0.00 +00	0.00 +00	0.00 +00
1	. 0 -0 1	0.00 +00	0.00 +00	0.00 +00	. -11	. 1 1 -0	. 0 -0	. 0 -0	. 0 -0	. 0 -0	0.00 +00	0.00 +00	0.00 +00
1	. 1 1 -0 1	0.00 +00	0.00 +00	0.00 +00	1.01 -1	1. 1 1 -0	. -0	. 1 1 -0	. 0 -0	. 0 -0	1. 0 -0	0.00 +00	0.00 +00
1	.00 -0 11	0.00 +00	.00 -0	.00 -0	.00 -0	. -0	0.00 +00	0.00 +00	0.00 +00	0.00 +00	0.00 +00	0.00 +00	0.00 +00
1	1. 1 1 0 -0 1	0.00 +00	0.00 +00	1. 1 1 0 -0	1. 1 1 0 -0	1. 1 1 0 -0	1.0 -0	0.00 +00	0.00 +00	0.00 +00	0.00 +00	0.00 +00	0.00 +00

						1														
1.	-0	0.00	+00	0.00	+	0	.	1.	-0	0.00	+00	0.00	+00	0.00	+00	0.00	+00	0.00	+00	
1.	-0	0.00	+00	0.00	+	0	.	1.	-0	0.00	+00	0.00	+00	0.00	+00	0.00	+00	0.00	+00	
1.1	-0	0.00	+00	0.00	+	0	1.	1.	-0	0.00	+00	0.00	+00	0.00	+00	0.00	+00	0.00	+00	
1.	1	0.00	+00	0.00	+	0	1.	.	-0	0.00	+00	0.00	+00	0.00	+00	0.00	+00	0.00	+00	
1.1	-0	1	0.00	+00	0.00	+	0	.	1.1	-0	1.1	-0	1.1	-0	1.	0	-0	0.00	+00	
1.	-0	1	0.00	+00	0.00	+	0	.	1.	-0	1.	-0	.	-0	0.00	+00	0.00	+00	0.00	+00
.1	-0	1	0.00	+00	0.00	+	0	.	.	0	-0	.	-0	-0						

	/ ( )	11 1 0.
	/ ( )	1.
	/ ( / )	1.
	/	0
	/%	0
	/	100
	/	/

10	.111	0			
110	1.	-0			
110		. -0			
10	.	1. -0			
10	.	1. -0			
10	.	1. -0			
10	.	1. 0 -0			
10	.	1.1 -0			
10	.000	. -0			
10	10.111	. -0			
1010	11.	. -0			
1110	1	. -0			
1110	1 .	. -0			
1 10	1 .	.1 -0			
1 10	1 .	. 0 -0			
1 10	1 .	. -0			
1 10	1 .	. 1 -0			
1 10	1 .000	. -0			
1 10	1.111	. -0			

1 10	1.111	.1 -0			
010	1.	-0			
110	.	0 -0			
110	.	-0			
10	.	0 -0			
10	.	-0			
10	.	-0			
10	.000	1 -0			
10	.111	0 -0			
10	.111	1. -0			
10	0.	1. -0			
010	1.	1. -0			
110	.	1. 1 -0			
110	.	1. -0			
10	.	1. -0			
10	.	1. 1 -0			
10	.000	1. -0			
10	0.111	1. 1 -0			
10	1.111	1. -0			
10	1.	1. 1 -0			
10	.	1. 0 -0			
010	.	1. 0 -0			
110	.	1. 0 -0			
110	.	1.1 -0			
10	.	1.1 -0			
10	1.000	1.0 -0			
10	.111	1.0 -0			
10	.111	1. 1 -0			
10	.	1. 1 -0			
10	.	. -0			
10	.	. -0			

-1

-1



		00 -0 1	0.00 +00	0.00 +00	0.00 +00	. -0	00 -0	00 -0	1. -0	0.00 +00	0.00 +00	0.00 +00	0.00 +00
		. 1 -0 1	0.00 +00	0.00 +00	. 1 -0	. 1 -0	. 1 -0	1 -0	0.00 +00	0.00 +00	0.00 +00	0.00 +00	0.00 +00
		.0 -0 1	0.00 +00	0.00 +00	0.00 +00	.0 -0	.0 -0	-0	0.00 +00	0.00 +00	0.00 +00	0.00 +00	0.00 +00
		-0 1	0.00 +00	0.00 +00	0.00 +00	-0	-0	-0	. -0	0.00 +00	0.00 +00	0.00 +00	0.00 +00
		1. -0 1	0.00 +00	0.00 +00	0.00 +00	1.1 -0	1. -0	1. -0	1. -0	-0	0.00 +00	0.00 +00	0.00 +00
		0 -0 1	0.00 +00	0.00 +00	0.00 +00	1.1 -0	0 -0	0 -0	. 1 -0	0.00 +00	0.00 +00	0.00 +00	0.00 +00
		1.1 -0 1	0.00 +00	0.00 +00	0.00 +00	. -1	1.10 -0	1.0 -0	1.1 -0	1.1 -0	1.1 -0	0.00 +00	0.00 +00
0		1. -0 1	0.00 +00	0.00 +00	0.00 +00	-0	1. -0	1. -0	1. -0	-0	0.00 +00	0.00 +00	0.00 +00
1		1.1 -0 1	0.00 +00	0.00 +00	0.00 +00	1.1 -1	.11 -0	.1 -0	1.1 -0	1.1 -0	-0	0.00 +00	0.00 +00
		1. 1 -0 1	0.00 +00	0.00 +00	0.00 +00	1. -11	1. 1 -0	1. 0 -0	1. 1 -0	1.1 -0	.1 -0	0.00 +00	0.00 +00
		1. 1 -0 1	0.00 +00	0.00 +00	0.00 +00	-1	1. 0 -0	1.1 -0	1. 1 -0	1.1 -0	. 0 -0	0.00 +00	0.00 +00
		1.00 -0 1	0.00 +00	0.00 +00	0.00 +00	-1	. -10	1. -0	. -0	1.00 -0	. -0	1.1 -0	0.00 +00
		. -0 1	0.00 +00	0.00 +00	. -0	. -0	. -0	1. 0 -0	0.00 +00	0.00 +00	0.00 +00	0.00 +00	0.00 +00
		1 -0 1	0.00 +00	0.00 +00	0.00 +00	1. -0	1 -0	1 -0	.01 -0	0.00 +00	0.00 +00	0.00 +00	0.00 +00
		-0 1	0.00 +00	0.00 +00	0.00 +00	-0	-0	-0	. -0	0.00 +00	0.00 +00	0.00 +00	0.00 +00
		1. -0 1	0.00 +00	0.00 +00	0.00 +00	-0	. -0	1. -0	1. -0	. 1 -0	0.00 +00	0.00 +00	0.00 +00
		1. -0 1	0.00 +00	0.00 +00	0.00 +00	-0	1. -0	1. -0	1. -0	1 -0	0.00 +00	0.00 +00	0.00 +00
0		1. -0 1	0.00 +00	0.00 +00	0.00 +00	. -1	-0	1.1 -0	1. -0	1.0 -0	. -0	0.00 +00	0.00 +00
1		1.1 -0 1	0.00 +00	0.00 +00	0.00 +00	. -1	. -0	1.0 -0	1.1 -0	1.1 -0	1. -0	0.00 +00	0.00 +00

	$f(\ )$	11 1 0.
	$f(\ )$	1.
	$f(\ / )$	1.
	$/$	
	$/\%$	0
	$/$	100
	$/$	$/$

10	.111	0				
110	1.	1. -0				
110		. -0				
10	.	. -0				
10	.	0.10 10				
10	.	. -0				
10	.	.1 -0				
10	.	.0 -0				
10	.000	.10 -0				
10	10.111	0.0 00	1 0	/	0	/
1010	11.	. -0				
1110	1.	.0 -0				
1110	1 .	. -0				
1 10	1 .	. -0				
1 10	1 .	. -0				
1 10	1 .	. -0				
1 10	1 .	. -0				
1 10	1 .000	. -0				
1 10	1.111	1 -0				

1 10	1.111	1. -0			
010		0.01			
110	.	1. -0			
110	.	0.01 0			
10	.	1. -0			
10	.	1. -0			
10	.	1. 1 -0			
10	.000	1. -0			
10	.111	1. -0			
10	.111	1. -0			
10	0.	1.1 -0			
010	1.	1.1 -0			
110	.	1.0 -0			
110	.	1.0 -0			
10	.	. -0			
10	.	. -0			
10	.000	. -0			
10	0.111	. 0 -0			
10	1.111	. -0			
10	.111	. 0 -0			
10	.	.0 -0			
010	.	. -0			
110	.	. -0			
110	.	. 0 -0			
10	.	.0 -0			
10	1.000	. -0			
10	.111	. -0			
10	.111	. -0			
10	.	. 1 -0			
10	.	. -0			
10	.	. -0			

-1

-1



		1. -0 1	0.00 +00	0.00 +00	0.00 +00	. 1 -0	1. -0	1. -0	. -0	0.00 +00	0.00 +00	0.00 +00	0.00 +00
		1 1 -0 1	0.00 +00	0.00 +00	1 1 -0	1 1 -0	1 1 -0	1. 1 -0	0.00 +00	0.00 +00	0.00 +00	0.00 +00	0.00 +00
		1. -0 1	0.00 +00	0.00 +00	0.00 +00	1. -0	1. -0	1. 1 -0	0.00 +00	0.00 +00	0.00 +00	0.00 +00	0.00 +00
		1. -0 1	0.00 +00	0.00 +00	0.00 +00	1. -0	1. -0	1. -0	1 1 -0	0.00 +00	0.00 +00	0.00 +00	0.00 +00
		1.0 -0 1	0.00 +00	0.00 +00	0.00 +00	. -0	1.0 -0	1.0 -0	1.0 -0	1. 1 -0	0.00 +00	0.00 +00	0.00 +00
		1. -0 1	0.00 +00	0.00 +00	0.00 +00	. -0	1. -0	1. -0	. -0	0.00 +00	0.00 +00	0.00 +00	0.00 +00
		. -0 1	0.00 +00	0.00 +00	0.00 +00	. -1	. 1 -0	. -0	. -0	. -0	. -0	0.00 +00	0.00 +00
0		1.0 -0 1	0.00 +00	0.00 +00	0.00 +00	1. -0	. -0	1.0 -0	1.0 -0	.10 -0	0.00 +00	0.00 +00	0.00 +00
1		. -0 1	0.00 +00	0.00 +00	0.00 +00	. -1	0 -0	. -0	. -0	. -0	1. -0	0.00 +00	0.00 +00
		. 1 -0 1	0.00 +00	0.00 +00	0.00 +00	1.1 -10	. -0	. -0	. 1 -0	. -0	. -0	0.00 +00	0.00 +00
		. -0 1	0.00 +00	0.00 +00	0.00 +00	1. -1	1.1 -0	. -0	. -0	. -0	. -0	0.00 +00	0.00 +00
		. -0 1	0.00 +00	0.00 +00	0.00 +00	1. -1	. -0	1.0 -0	. -0	. -0	. -0	.10 -0	0.00 +00
		. -0 1	0.00 +00	0.00 +00	. -0	. -0	. -0	.10 -0	0.00 +00	0.00 +00	0.00 +00	0.00 +00	0.00 +00
		1. 1 -0 1	0.00 +00	0.00 +00	0.00 +00	1.1 -0	1. 1 -0	1. 1 -0	.0 -0	0.00 +00	0.00 +00	0.00 +00	0.00 +00
		1. -0 1	0.00 +00	0.00 +00	0.00 +00	1. -0	1. -0	1. -0	. -0	0.00 +00	0.00 +00	0.00 +00	0.00 +00
		. -0 1	0.00 +00	0.00 +00	0.00 +00	1. -0	. 1 -0	. -0	. -0	. 1 -0	0.00 +00	0.00 +00	0.00 +00
		. -0 1	0.00 +00	0.00 +00	0.00 +00	. -0	. 0 -0	. -0	. -0	1. -0	0.00 +00	0.00 +00	0.00 +00
0		. -0 1	0.00 +00	0.00 +00	0.00 +00	. -1	1. 1 -0	. 1 -0	. -0	. 1 -0	. -0	0.00 +00	0.00 +00
1		. -0 1	0.00 +00	0.00 +00	0.00 +00	1 -1	. -0	. -0	. -0	. -0	. -0	0.00 +00	0.00 +00



1

11.



1#

.1

1 0

01 0-

1 -

1.0

1

1 0-

1 1-

- - - - -

1 - 0

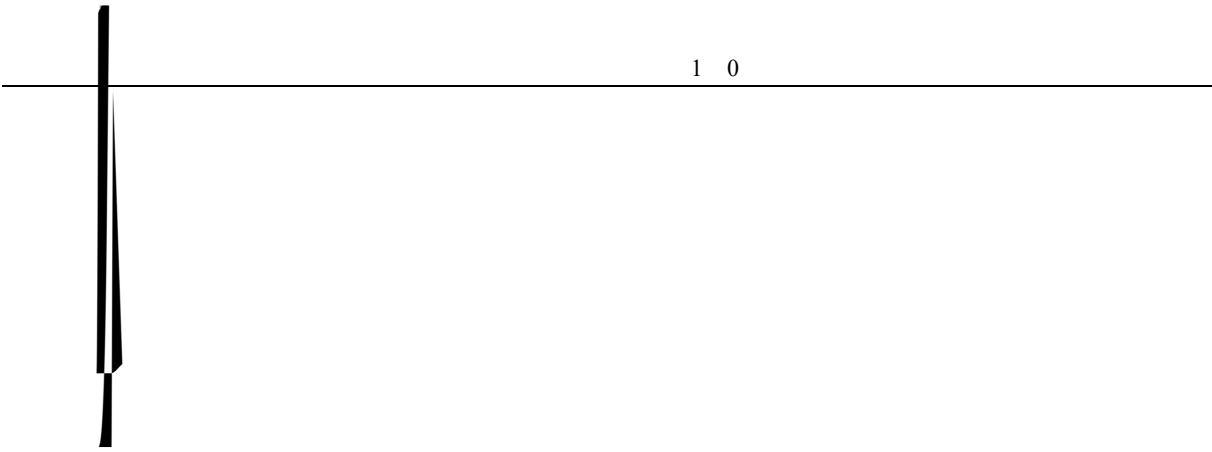

001 - 01



||

0 - 01





	1
	11
	1 0 .0

1 0 .0

0

1

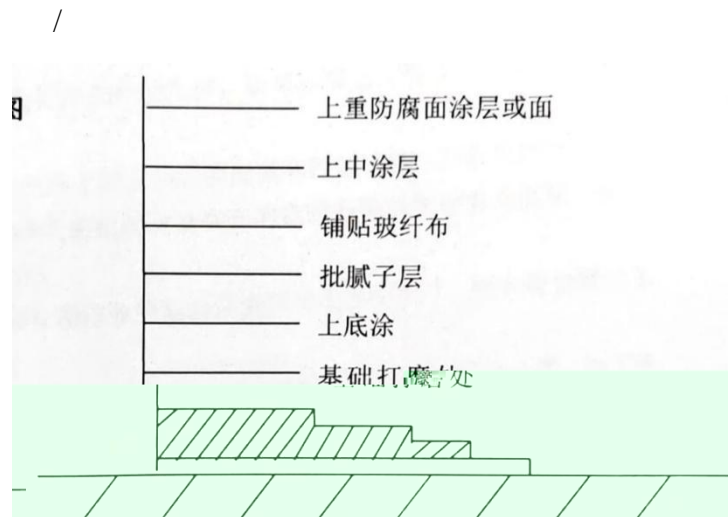



---

1		
	/	
		0



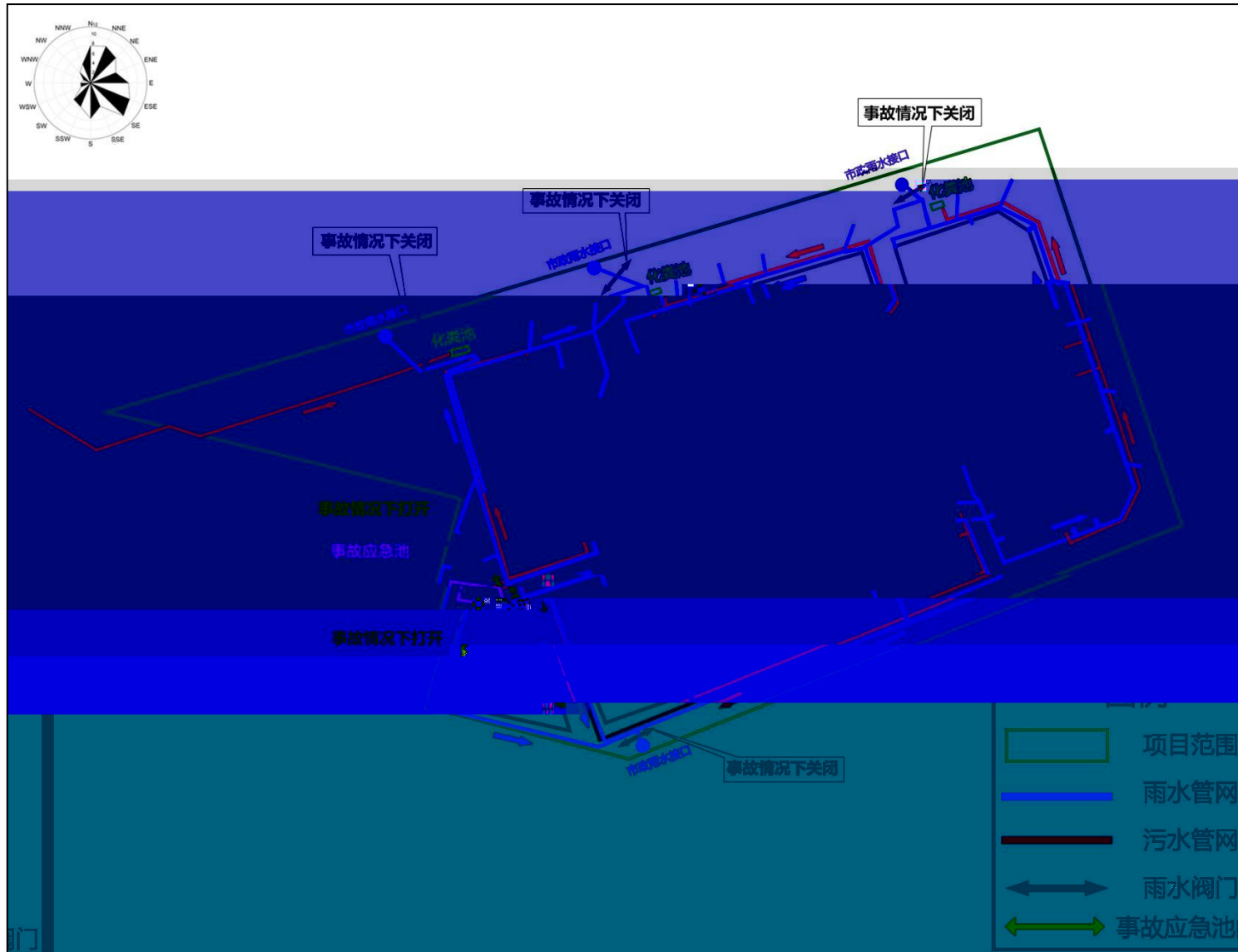



ž







1



1

11

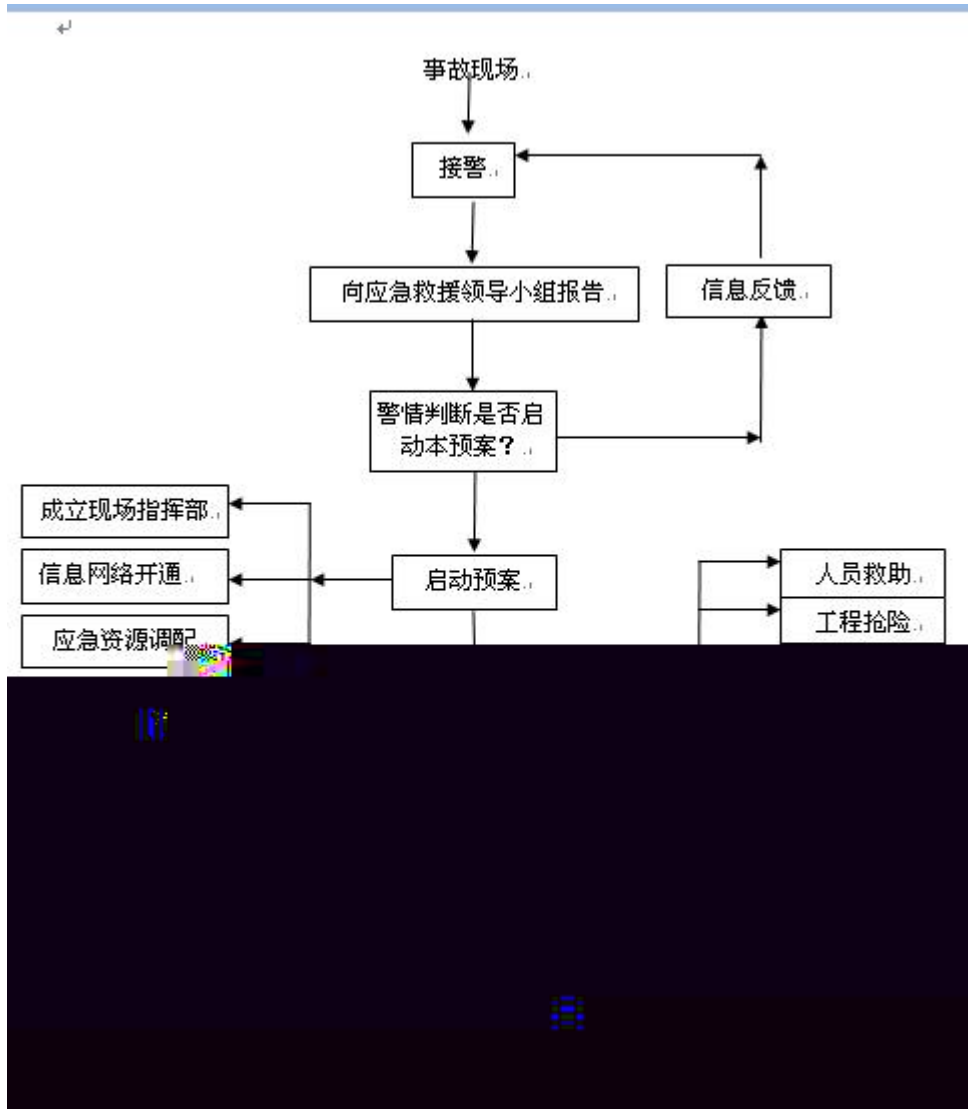

1 0

11

1 0

1

||

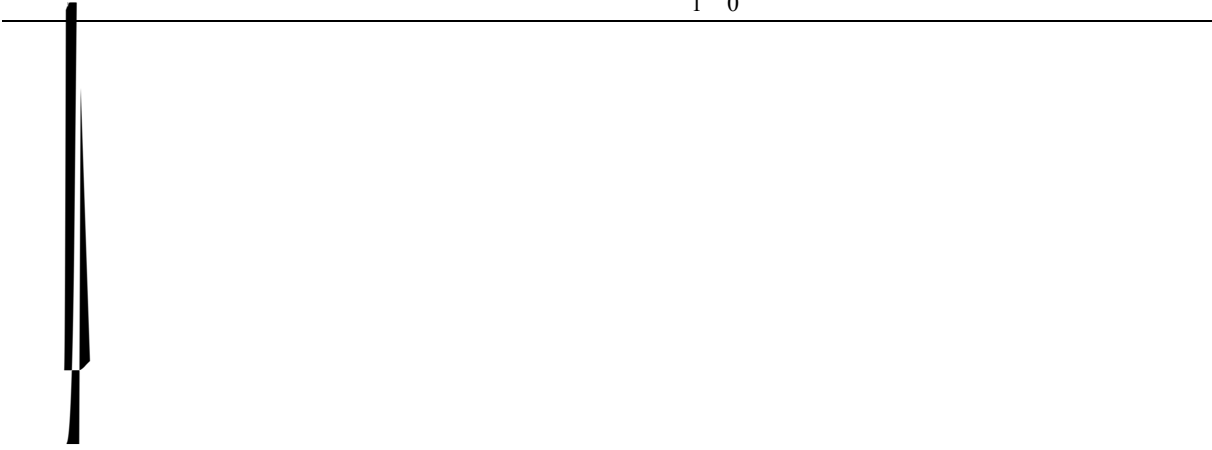

1



||



11

1 0



1-01

1

||

1		
1		1 011 1
		/
		/
		1

		1	
			0

		/		/	0.101
		/		/	10
/	/	0.	0	/	
/	0.	/	0.00000		1 10 <sup>-</sup> /

			/	/	/
		-1	1 0	/	/
			.	/	/
			/	/	/
		/	/	/	/

			/		/
		/	/	/	/
			/	/	/
		/	/	/	/

		/	/	/	/ /
		/	/	/	/
		/	/	/	/ /
		/	/	/	/

		/		/	0.101

		/		/	10
/	/	0.0	/	0	0
/	0.	/	0.0000		1 10 <sup>-</sup> /

			/	/	/
		-1	0	/	/
		-		/	/
			/	/	/
/	/	/	/	/	/

			/	/	/
/	/	/	/	/	/
		/	/	/	/
/	/	/	/	/	/

		/	/	/	/ /
/	/	/	/	/	/
		/	/	/	/ /
/	/	/	/	/	/

--	--	--	--	--	--

		/		/	0.101
		/	0	/	10
/	/	0.		/	
/	0.	/	0.000    0 0		1 10 <sup>-</sup> /

			/	/	/
		-1	1 0	/	/
			0	/	/
			/	/	/
		/	/	/	/
			/	/	/
		/	/	/	/
			/	/	/
		/	/	/	/
			/	/	/
		/	/	/	/

		/		0	. 0	0.1 1	0.00	. 0
			00				00	
			00					
					00			
					1			
					1			
					1			
					1			
			1		1	1		
				1	0	10	100	100





.	11.1	0	1	100
.	11.1		1	00



0.00 %

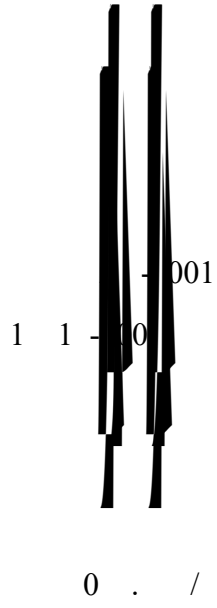

	/	/		/	/
1#	100	.	0		0
#	0	1.			10.
#	0	0	0		0
#	1 0	0		10	.
#	100	0		.	0
#	0	0		1 .	1 .
#	100	100			1.
#	10	10 .			1.
#	1	1		1 0	.

1 0

---

	<b>0</b> 1	1 .	0 .	1	
--	------------	-----	-----	---	--

			/																
1 #			100	10000	0	1 0	00	0	--	000	--	000	--	0	--	10			
#			0	11		11	1	0	--	1	10	1 1	--		--	10			
#			0	000	000	0	00	--	--	000	--	10	00	--	--				
#			100	000	00	1 0	1 0	--	--	000	00	0	00	--	--				

		/														
		0														
#		100	1000	0	0	0	--	0	00	--	10	--	--	--		
#		00	1000	0	0	0	--	--	00	10	0	--		--		0
		1 0														
#		100	1000	0	1 0	1 0	00	--	00	--	10	--	--	--	--	10
#		0	#													
		0	#				8#				2#					
#		1	0	--	--	--	--	--	00	--	--	--	--	--	1 0	0
		01														

1 0

01 /

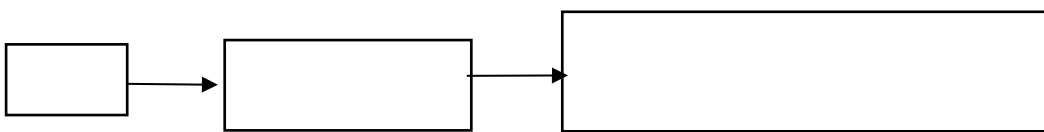
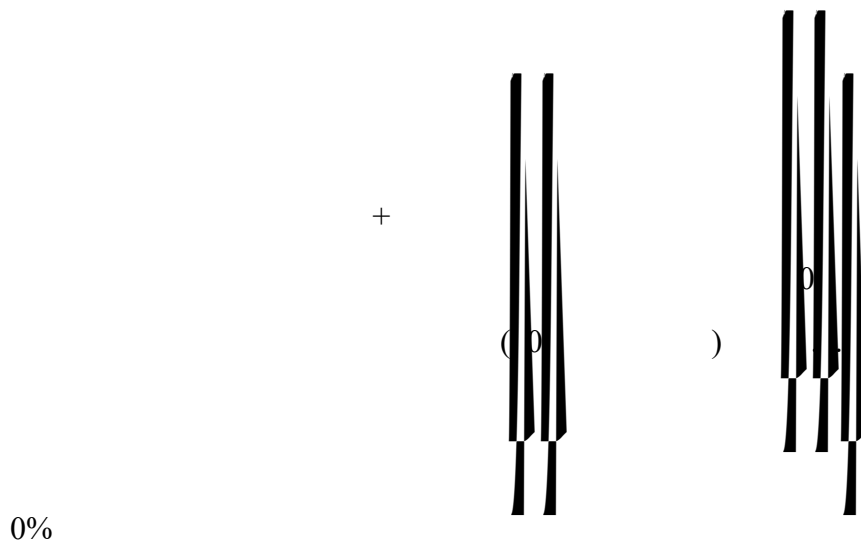
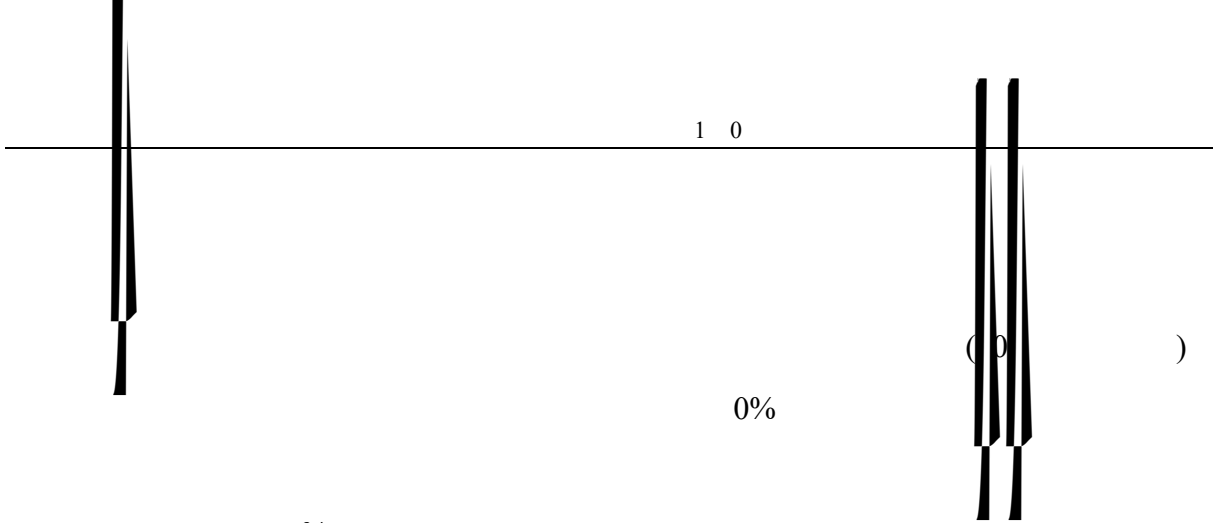

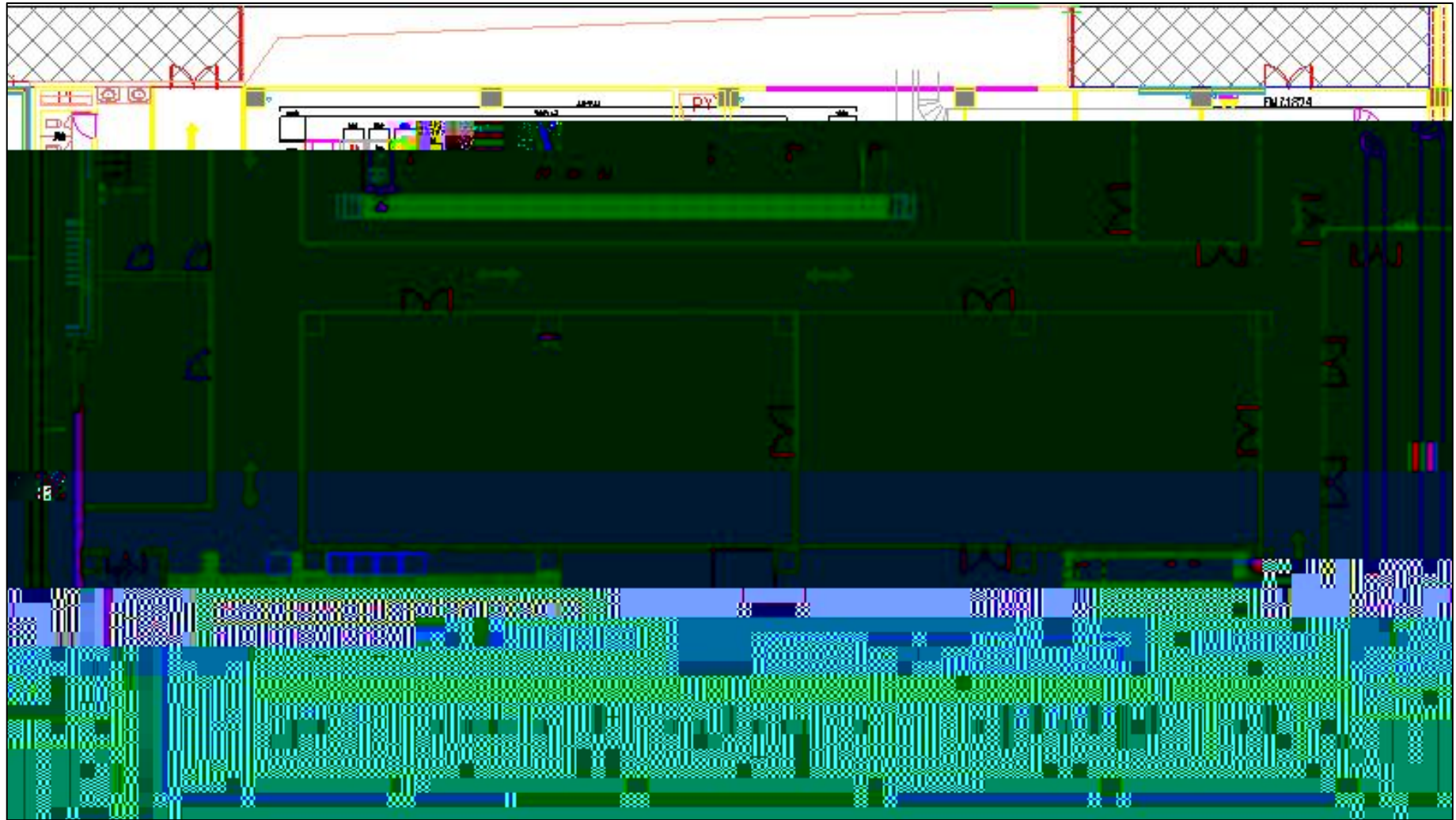

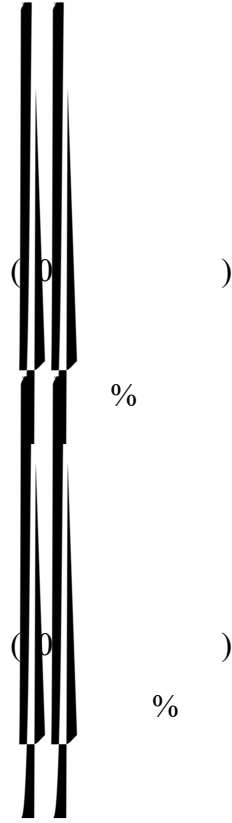

+

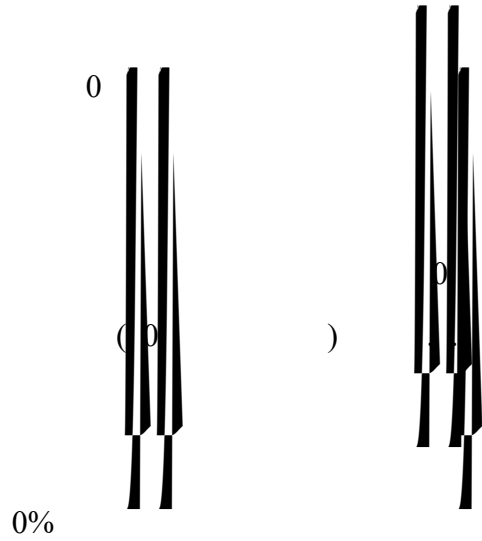
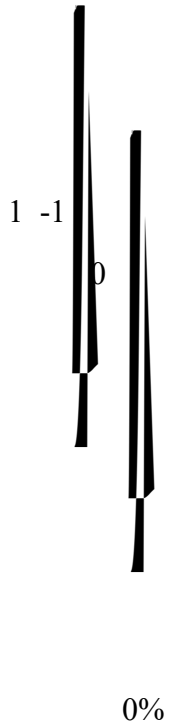

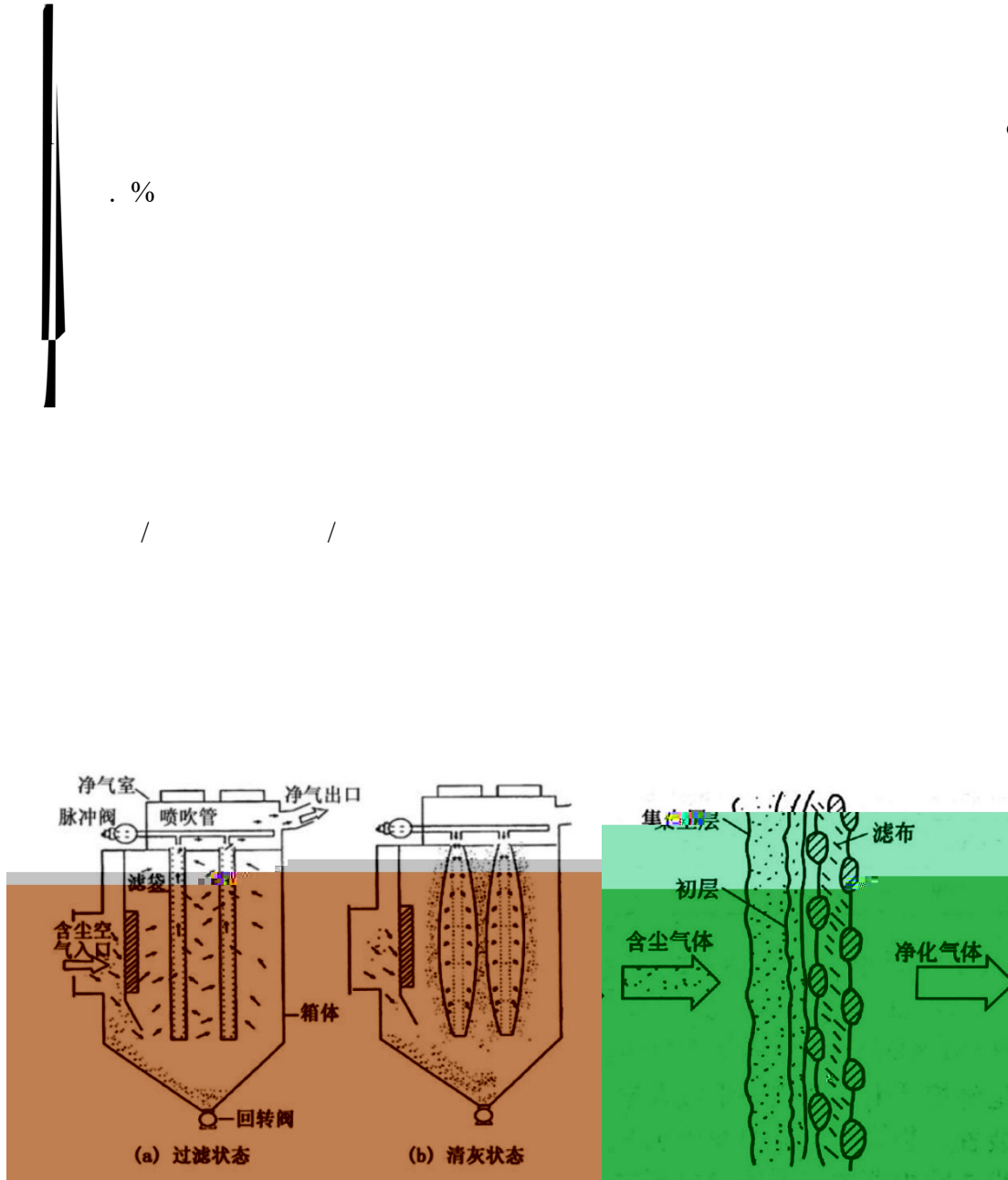

%

/ - 001

- 00

1.0 /

1

1

% %

.1

10%

+

0%

- 01

,

%

0%

10%

+

10%

- 01



/

/

/

/

1

10. /

0. /

+

||

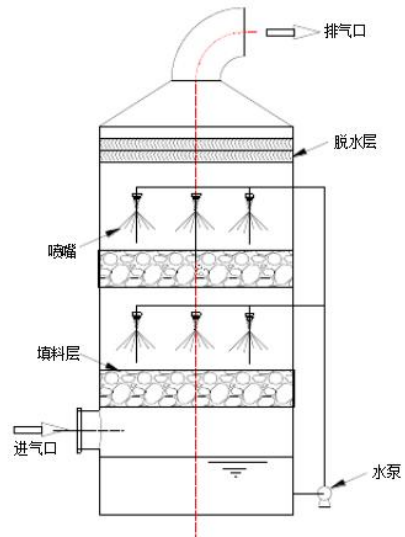
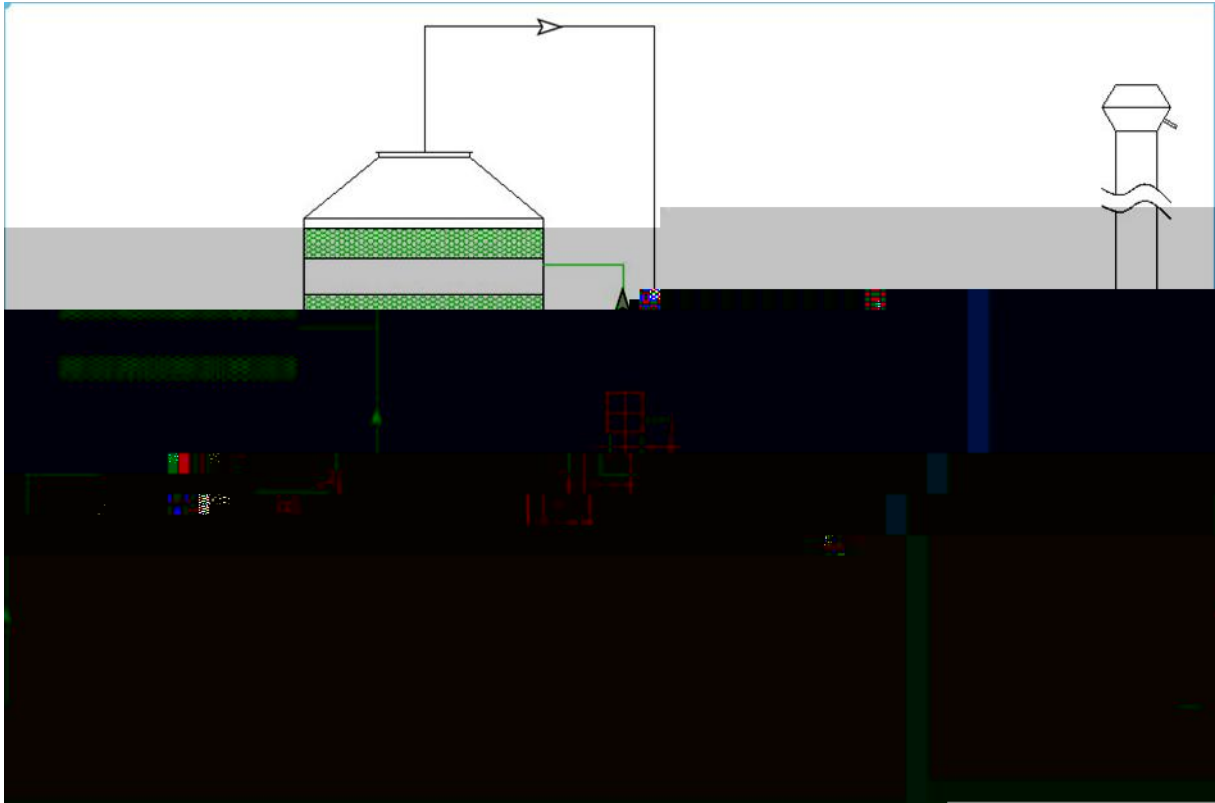

1 - 0 ( )

1 - 0 ( )

1 - 0 ( )

||

10 - 0 ( )

0 - 0 ( )

0 - 0 ( )

0 - 0 ( )



( )

0 ( )

- -



0- ( )





1			00-0 1-	.	/	
	/		00-0 1-	0.1	/	
		1	-0 -1	1	.	/

/

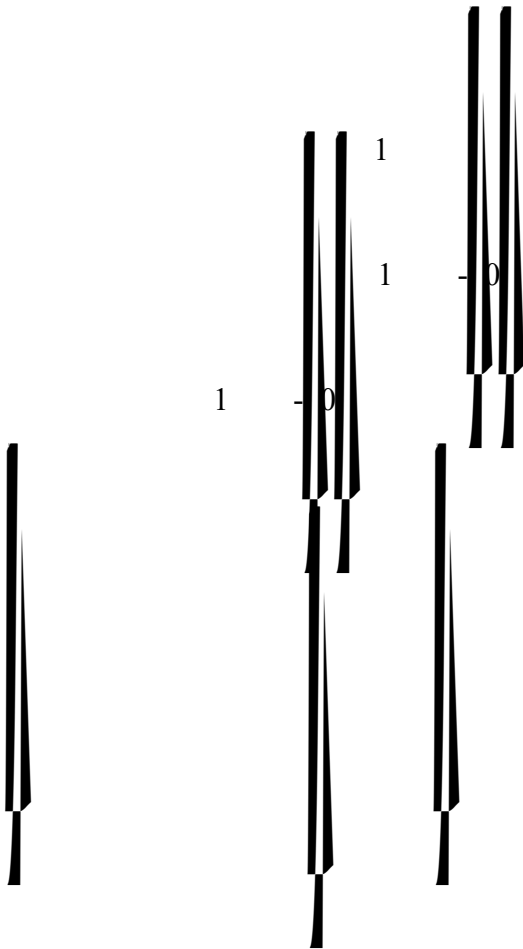

10 /

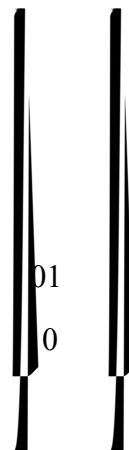

①

②

③

④

⑤

⑥

⑦

⑧



( / 0 - 01 )



10

	10

01

0

010  
0

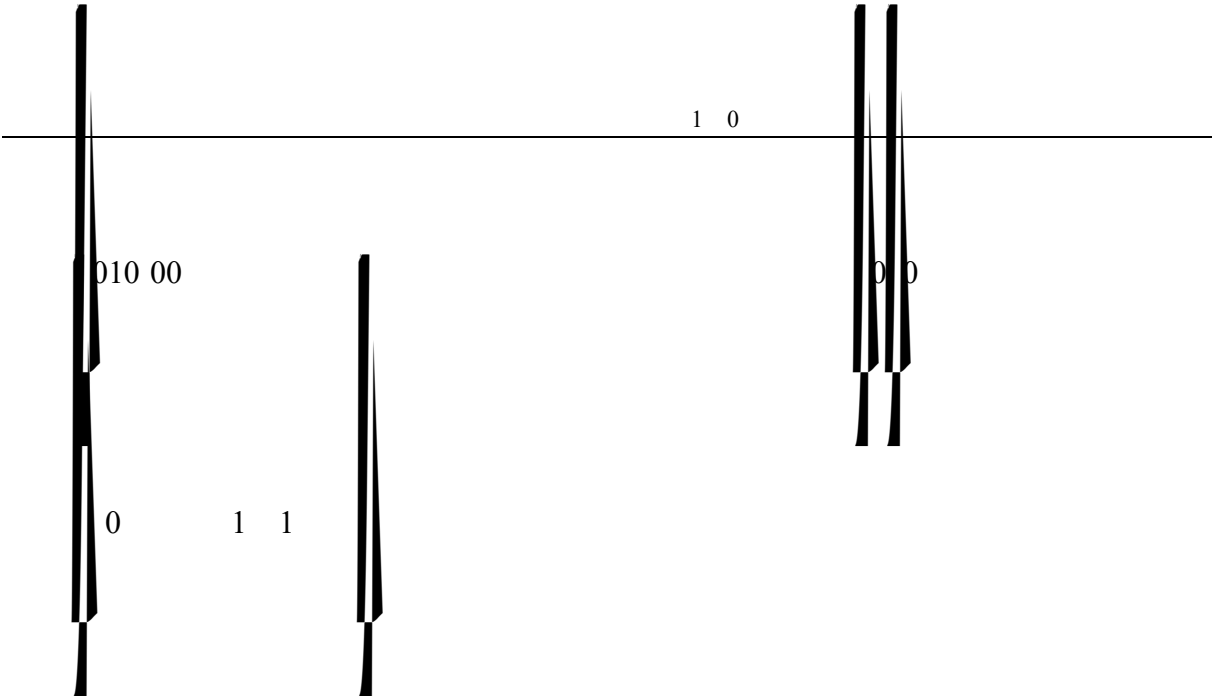

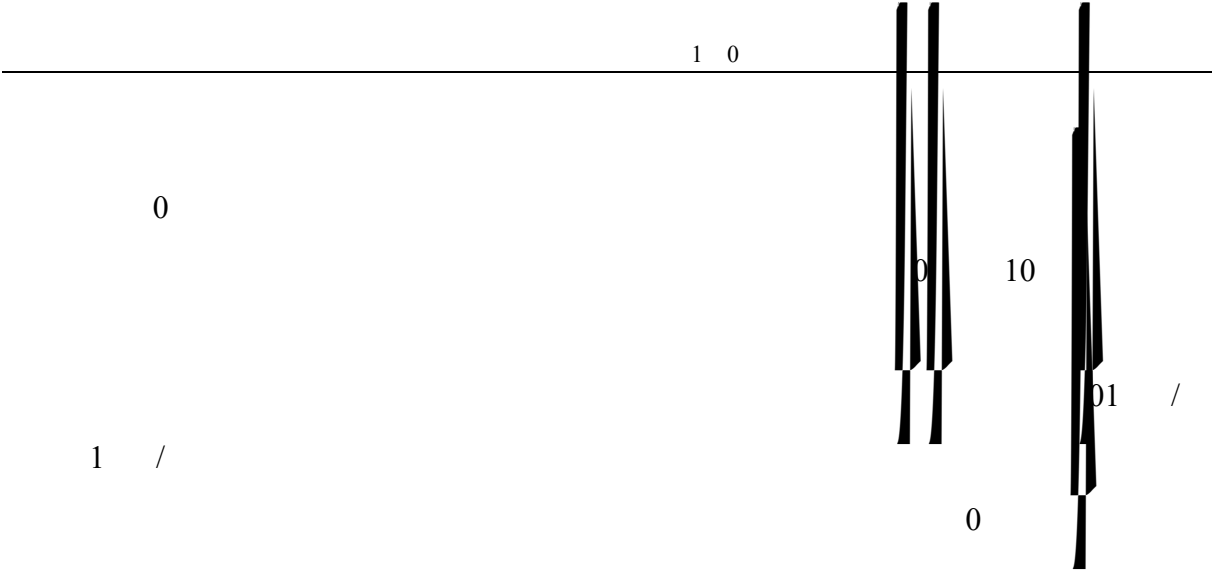





0%

%

%

%

+

0%

0

(1)



00

0

10%

00

0

+



---

	0.	( )	( )
	<b>  </b>		

( )

00

0

10.1-1





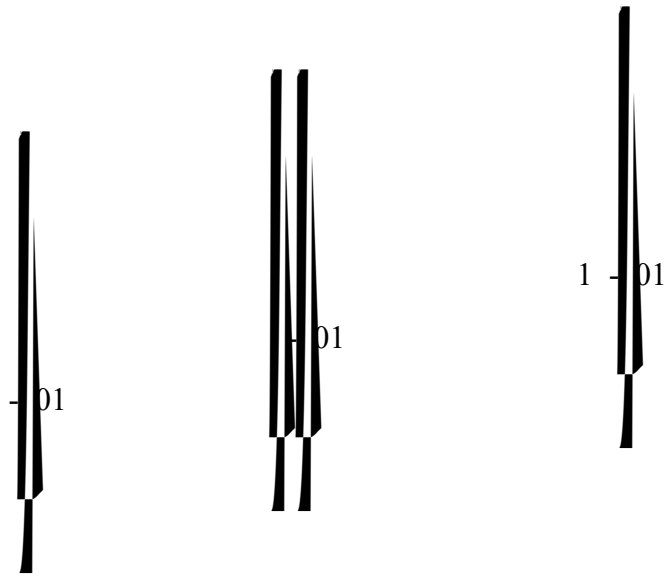

		/	( / -001) 1 00-00

				/ -001
				/ -01

1



1



10



1



00



00



-

1

1



-

			/	/	/	0.01 /			0.1 /		
							/	1 - 00		/	/
				/					/	/	/
				/		/			/	/	/
				/					/	/	/
									/	/	/
									/	/	/
									/	/	/

1

0 . /

0.0 /

1

1

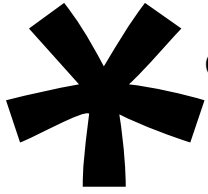

C+X- /c





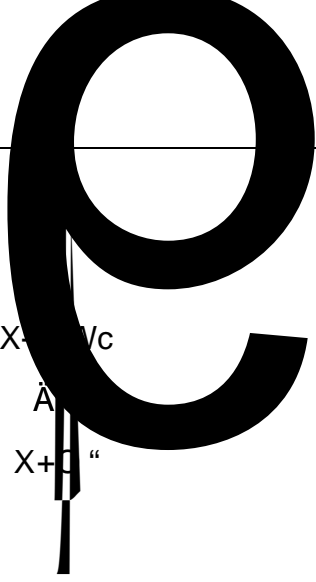

Á

X+ “



XGÂ



- ①
- ②
- ③

01

1

1				0.1 / 0.0 /	+		
				0.1 / 0.01 /		( / - 001)	
				0.10 /		/ - 001	
				0.0 /		/ - 001	
				1 0 /		( / 001)	/
				0 . /		/1 - 01 ( / - 00)	
				/			

						1    -    00	
				1    /			/
				0.0 /			
				1 . 1 /			
				0. /			
				.			
		/		0.1 /			
				1    .    /			





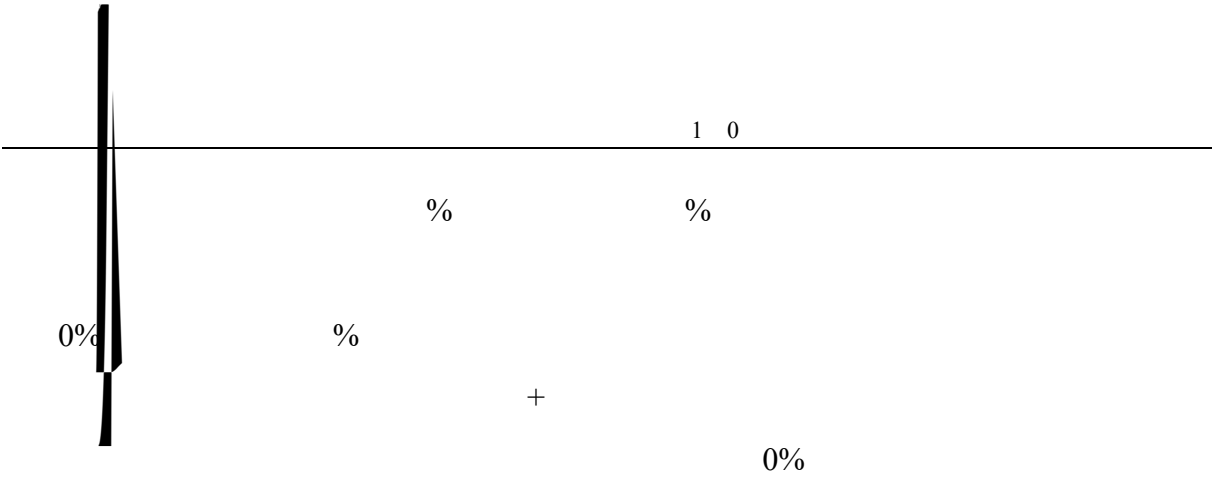

0 . /

10%

0 . /

1

1

- 0 0



1 0

1

-00



1 000

1 0

0

